



PROVINCE OF BENGUET
 La Trinidad
BIDS AND AWARDS COMMITTEE
 (INFRASTRUCTURE PROJECTS)

Project Number 2022089

MEMORANDUM TO:

Mr. / Ms.: BAC SUPPORT STAFF
 (Canvasser)

Please furnish each of the following dealer/ establishment a copy of the solicitation "bid" tender for the project
IMPROVEMENT/ PAVEMENT OF TAMOCMOC FARM TO MARKET ROAD, TOPDAC, ATOK
 for use of TOPDAC, ATOK, BENGUET to be opened on June 7, 2022 at 9:00AM ABC: 1,000,000.00

	NAME OF CONSTRUCTION FIRM	ADDRESS	RECEIVED	DATE
1				
2				
3				
4				
5				
6				
7				
8				
9				
10				

ATTY. SUNNY G. SACLA
 BAC - INFRA Chairperson

CERTIFICATION

I/We the undersigned, hereby jointly and severally certify to have given each of the above contractor/establishments a copy of the solicitation bid papers and inform them that they shall submit their quotations before the time of opening of the same.

CANVASSER/S:

CEFERINO GOLINGAB JR. / SEVENTINA C. OWAY
 BAC SUPPORT STAFF



PROVINCE OF BENGUET
 La Trinidad
BIDS AND AWARDS COMMITTEE
 (INFRASTRUCTURE PROJECTS)

Project Number 2022089

MEMORANDUM TO:

Mr. / Ms.: BAC SUPPORT STAFF
 (Canvasser)

Please furnish each of the following dealer/ establishment a copy of the solicitation "bid" tender for the project

IMPROVEMENT/ PAVEMENT OF TAMOCMOC FARM TO MARKET ROAD, TOPDAC, ATOK

for use of TOPDAC, ATOK, BENGUET to be opened on June 7, 2022 at 9:00AM ABC: 1,000,000.00

	NAME OF CONSTRUCTION FIRM	ADDRESS	RECEIVED	DATE
1				
2				
3				
4				
5				
6				
7				
8				
9				
10				

ATTY. SUNNY G. SACLA
 BAC - INFRA Chairperson

CERTIFICATION

I/We the undersigned, hereby jointly and severally certify to have given each of the above contractor/establishments a copy of the solicitation bid papers and inform them that they shall submit their quotations before the time of opening of the same.

CANVASSER/S:

CEFERINO GOLINGAB JR. / SEVENTINA C. OWAY
 BAC SUPPORT STAFF



Republic of the Philippines
 PROVINCE OF BENGUET
 La Trinidad
BIDS AND AWARDS COMMITTEE
 (INFRASTRUCTURE PROJECTS)

Project Number: 2022089 Source of Fund: 20% PDF CY 2022

Name of the Project: IMPROVEMENT/ PAVEMENT OF TAMOCMOC FARM TO MARKET ROAD, TOPDAC, ATOK No. of Calendar Days: 52

Location of the Project: TOPDAC, ATOK, BENGUET ABC: 1,000,000.00

REQUEST FOR QUOTATION
NEGOTIATED PROCUREMENT- (SMALL VALUE PROCUREMENT)

Sir/Madam:

Please quote your lowest price on the project listed below. Please Submit your Quotation duly signed by you to the Bids and Awards Committee not later than **8:30 AM on June 7, 2022** c/o BAC Support, 2nd Floor, BAC Office, Capitol La Trinidad. To be opened at **9:00am** on the same day.

Thank you very much.

ATTY. SUNNY G. SACLA
 BAC- INFRA Chairperson

INSTRUCTIONS:

"PLEASE SEAL YOUR QUOTATIONS"

1. All Entries must be typewritten or handwritten (please write legibly & do not use pencil);
2. To quote for this Contract, a Contractor must meet the following major criteria: (a) Filipino Citizen or 75% Filipino-owned partnership, corporation, cooperative, or joint venture, with PCAB License applicable to the type and cost of this contract;
3. Clustered projects shall be treated as one project. Any adverse findings on any of the clustered projects shall be a ground for disqualification.
4. All particulars relative to the Evaluation of quotation, Post-Qualification and award of contract shall be governed by the pertinent provision of revised R.A. 9184 and its implementing rules and regulations;
5. Documentary requirements to be submitted with this RFQ:
 - a) Detailed Estimates with pertinent supporting documents (e.g. Summary Sheet)
 - b) Mayor's/Business Permit;
 - c) PhilGEPS Registration Number; _____ (Kindly indicate)
 - d) PCAB License;
 - e) Latest Income/Business Tax Returns for ABC above P500,000.00;
 - f) Omnibus Sworn Statement for ABC above P500,000.00; and
 - *in lieu of 'b' & 'c', certified true copy of PhilGEPS Platinum membership may be submitted.*
6. The only authorized person to secure and drop quotations (RFQs) and documents is the contractor himself/herself or his/her representative through a Special Power of Attorney (SPA), particularly stating therein the title of the project/s which the principal (contractor) is granting authority for his/her agent with the power to secure, drop and sign in behalf of the principal any documents required in the procurement proceedings (R.A. 9184);
7. Detailed estimate for all items of work shall be itemized (not lumpsum);
8. Detailed Estimates for reinforcing steel bars shall be itemized according to its size;
9. To submit the following additional documentary requirements within three (3) days from Notice of the BAC:
 - a) Construction Schedule and S-Curve;
 - b) Cash Flow;
 - c) Manpower Utilization Schedule;
 - d) Equipment Utilization Schedule;
 - e) Construction Safety and Health Program;
 - f) Construction Method;
 - g) PERT-CPM;
 - h) Provincial Permit;
10. All Erasures shall be countersigned;

****Non-compliance to the foregoing instructions shall be a ground for disqualification.**

NO.	PROJECT TITLE	UNIT	QUANTITY	UNIT PRICE	TOTAL PRICE
1	IMPROVEMENT/ PAVEMENT OF TAMOCMOC FARM TO MARKET ROAD, TOPDAC, ATOK				
	SCOPE OF WORK				
	Spl. A	Project Billboard	whole	whole	
	Spl. B	Construction Health and Safety Requirements	whole	whole	
	B.9	Mobilization/ Demobilization	whole	whole	
	102	Excavation	cu.m	90.65	
	105	Subgrade Preparation	sq.m	612.65	
	201	Aggregate Base Course	cu.m	30.63	
	311(1)c	PCCP (Class "A")	sq.m	612.65	
	Spl. C	Haul Out (Excavated Materials)	cu.m	90.65	
MINIMUM EQUIPMENT REQUIRED		IN FIGURES:			
1	Cargo Truck				

2	Concrete Vibrator			
1	1 Bagger Concrete Mixer			
1	Concrete Saw, Blade 14" dia. (7.5hp)			
1	Water Truck Pump (1000gal)			
1	Bar Cutter, Single Phase			
1	Portable Plate Compactor			
1	Dump Truck			

BID AMOUNT IN FIGURES:

BID AMOUNT IN WORDS:

CANVASSER/S:

CERTIFICATION

This is to certify that I have full knowledge, authority and responsibility in distributing and/or collecting the Request for Quotation in accordance to the guidelines in securing prices for the Bids and Awards Committee on Infrastructure.

CEFERINO GOLINGAB JR. / SEVENTINA C. OWAY
BAC SUPPORT STAFF

After having carefully read and accepted your general conditions.
I/We quote you on the project noted above.

Name of Construction Firm(As indicated in PCAB License) & Address

Name of Owner
(Signature over printed name)

Telephone / Cellphone Number
e-mail Address

Date:

GENERAL NOTES

I. SCOPE OF WORK

- ✓ SPL ITEM A: FABRICATION & INSTALLATION OF PROJECT BILLBOARD
- ✓ SPL ITEM B: CONSTRUCTION HEALTH & SAFETY REQUIREMENTS
- ✓ ITEM B-9: MOBILIZATION/DEMOBILIZATION
- ✓ ITEM 102: EXCAVATION (C.E.)
- ✓ ITEM 105: SUBGRADE PREPARATION
- ✓ ITEM 201: AGGREGATE BASE COURSE
- ✓ ITEM 311: PCCP (Class "A", 1:2:3, f'c=3,500PSI @ 14days)
- ✓ SPL ITEM C: HAULOUT

II. EQUIPMENTS TO BE USED IN THE PROJECT

- ✓ 1. ONE UNIT - CARGO TRUCK
- ✓ 2. ONE UNIT - BAR CUTTER, SINGLE PHASE
- ✓ 3. ONE UNIT - CONCRETE SAW, BLADE 14" dia. (7.5HP)
- ✓ 4. ONE UNIT - WATER TRUCK PUMP (1000 gal)
- ✓ 5. ONE UNIT - PORTABLE PLATE COMPACTOR
- ✓ 6. ONE UNIT - ONE BAGGER CONCRETE MIXER
- ✓ 7. TWO UNIT - CONCRETE VIBRATOR
- ✓ 8. ONE UNIT - DUMP TRUCK

III. SPECIFICATIONS

A) GENERAL

1. PROJECT BILLBOARD SHALL BE STRICTLY COMPLETED PRIOR TO THE START OF THE PROJECT.
 2. ALL DIMENSIONS HEREIN ARE IN METERS UNLESS OTHERWISE SPECIFIED.
 3. WORKMANSHIP SHALL CONFORM TO THE STANDARDS OF THE RESPECTIVE TRADE.
 4. APPROVED REVISIONS MADE DONE HEREIN TO SUIT EXISTING FIELD CONDITIONS.
 5. OTHER DETAILS NOT SHOWN HEREIN OR NOT CLEARLY UNDERSTOOD SHALL BE REFERRED TO THE PROJECT IN-CHARGE FOR PROPER VERIFICATION AND RECOMMENDATIONS.
 6. PROVIDE TRAFFIC / WARNING SIGNS AS SAFETY MEASURES.
 7. AGGREGATES SHALL BE STRICTLY TAKEN FROM THE PROGRAMMED SOURCE.
 8. WATER TO BE USED IN CONCRETING SHALL BE FRESH WATER, FREE FROM OIL AND VEGETABLES MATERIALS.
 9. STRUCTURE EXCAVATION SHALL BE MADE TO MEET THE ESTABLISHED DESIGN GRADE, ELEVATION AND DIMENSIONS AS SHOWN ON PLANS.
- B) SUB-GRADE PREPARATION
 1. SUB-GRADE PREPARATION SHALL BE FULLY ACCOMPLISHED AS TO COMPACTION, LINE & GRADE.
 2. SUB-GRADE PREPARATION SHALL BE EXTENDED TO FULL WIDTH OF THE ROADWAY.
 - C) AGGREGATE BASE COURSE
 1. AGGREGATE BASE COURSE SHALL CONSIST OF HAND-DURABLE PARTICLES OR FRAGMENTS OF CRUSHED SLAGS OR CRUSHED OR NATURAL GRAVEL AND FILLER OF NATURAL OR CRUSHED SAND OR OTHER FINELY DIVIDED MINERAL MATTER.
 2. AGGREGATE BASE COURSE SHALL BE COMPACTED ON A PREPARED SUB-GRADE IN ACCORDANCE WITH THE LINES, GRADES, THICKNESS AND TYPICAL CROSS SECTIONS SHOWN ON PLANS.

D) PCCP

1. CONCRETE MIXTURE SHALL BE CLASS "A", f'c=3,500 PSI @ 14 DAYS).
2. PROVIDE 16mmØ x 0.60m ROUND BAR BOWTIES AT EVERY END OF CONCRETE POURING. (CONSTRUCTION JOINT)
3. PROVIDE 16mmØ x 0.60m NSB AT EVERY 0.60m O.C. (CONSTRUCTION JOINT FOR 2 LANE PAVEMENT)
4. WATER TO BE USED IN CONCRETING SHALL BE FRESH WATER, FREE FROM OIL AND VEGETABLES MATERIALS.
5. PROVIDE 6mm x 50mm HOT ASPHALT FILLER ON EXPANSION & CONSTRUCTION JOINT.
6. EXPANSION JOINT SHALL BE SPACED AT EVERY 4.50m SPAN. CUT 4-6 HOURS AFTER CONCRETE POURING.
7. PAYMENT FOR PAVEMENT WITH DEFICIENCY IN THICKNESS AND STRENGTH SHALL BE COMPUTED BASED ON THE DPWH STANDARDS & SPECIFICATIONS (ITEM 311.3.22-311.3.22 VOL. 11, 1995).

E) CONSTRUCTION HEALTH & SAFETY REQUIREMENTS

- LABOR:
1. PAINT TIME SAFETY PRACTITIONER
 2. FIRST AIDER
- MATERIALS: (PERSONAL PROTECTIVE EQUIPMENTS)
1. SAFETY SHOES
 2. SAFETY HELMET
 3. SAFETY GLOVES
 4. REFLECTORIZED VEST
 5. FIRST AID KIT
 6. DOH APPROVED FACE MASK
 7. MEDICAL KITS (SANITIZER, ALCOHOL, THERMAL SCANNER, ETC)

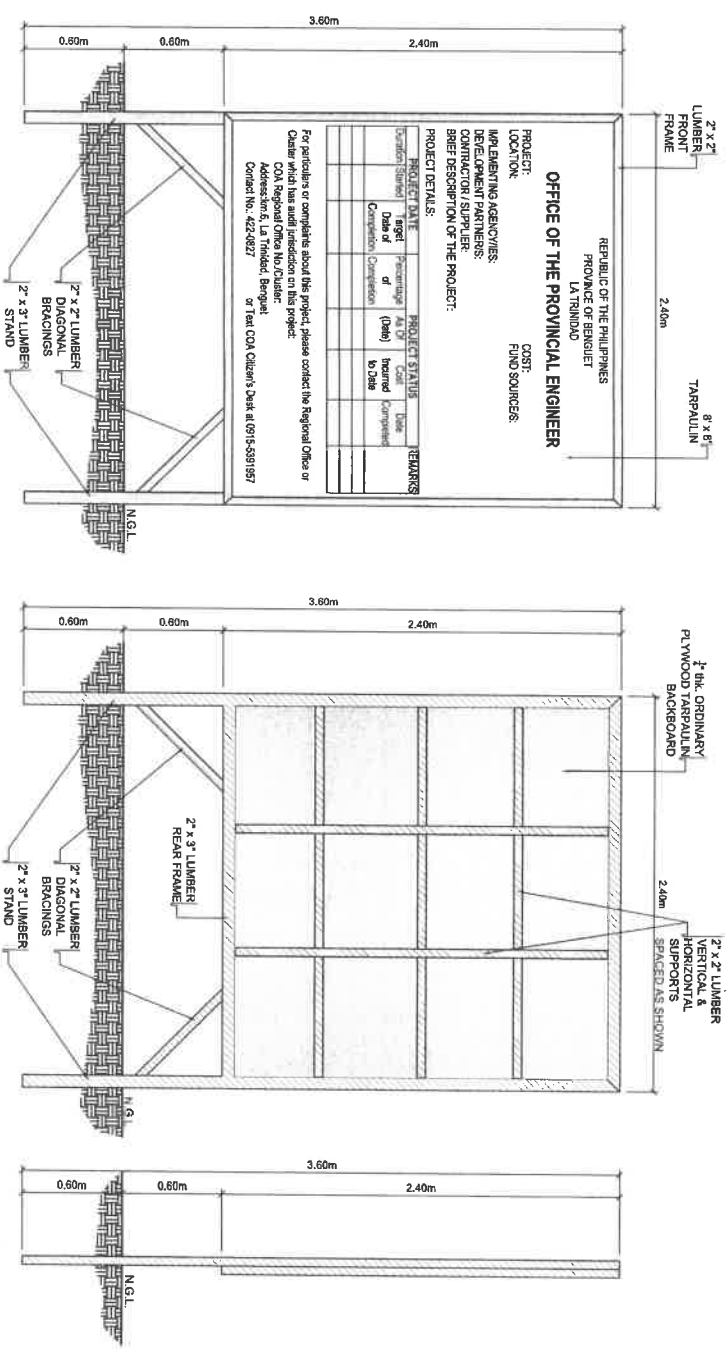

NOTE:
 TAPERALUM : WHITE -8FT x 8FT
 SUB-INFORMATION : "1"
 FONT : HELVETICA
 FONT COLOR : BLACK

PROPOSED PROJECT BILLBOARD w/ STAND
 NOT DRAWN TO SCALE

	PROJECT TITLE / LOCATION: IMPROVEMENT/PAVEMENT OF TAMOCMOC FARM TO MARKET ROAD, TOPDAC, ATOK	PREPARED BY: RENZELLE J. MITO ENGINEER	CHECKED BY: JOSEPH R. SALVADOR ENGINEER	REVIEWED BY: FRANCISCO B. BANGUOYAO ASSISTANT PROVINCIAL ENGINEER	APPROVAL RECOMMENDED BY: JERRY L. BOGANOG PROVINCIAL ENGINEER	APPROVED BY: MECHOR D. DICIAS PROVINCIAL GOVERNOR
PROVINCE OF BENGUET WANGAL, LA TRINIDAD	TOPDAC, ATOK	ENGINEER	ENGINEER	ASSISTANT PROVINCIAL ENGINEER	PROVINCIAL ENGINEER	PROVINCIAL GOVERNOR

THIS SITE
IMPROVEMENT/PAVEMENT OF
TAMOCMOC FARM TO MARKET
ROAD, TOPDAC, ATOK



LOCATION/TOPOGRAPHIC MAP
 (1 Km. Radius-16.55361°N, 120.71582°E)
 SCALE NDT'S

PROVINCE OF BENGUET  WAGSAL, LA TRINIDAD	PROJECT TITLE / LOCATION: IMPROVEMENT/PAVEMENT OF TAMOCMOC FARM TO MARKET ROAD, TOPDAC, ATOK	PREPARED BY:  RENZELLE JOY S. MILLO ENGINEER R. 1
A 2		2 / 5

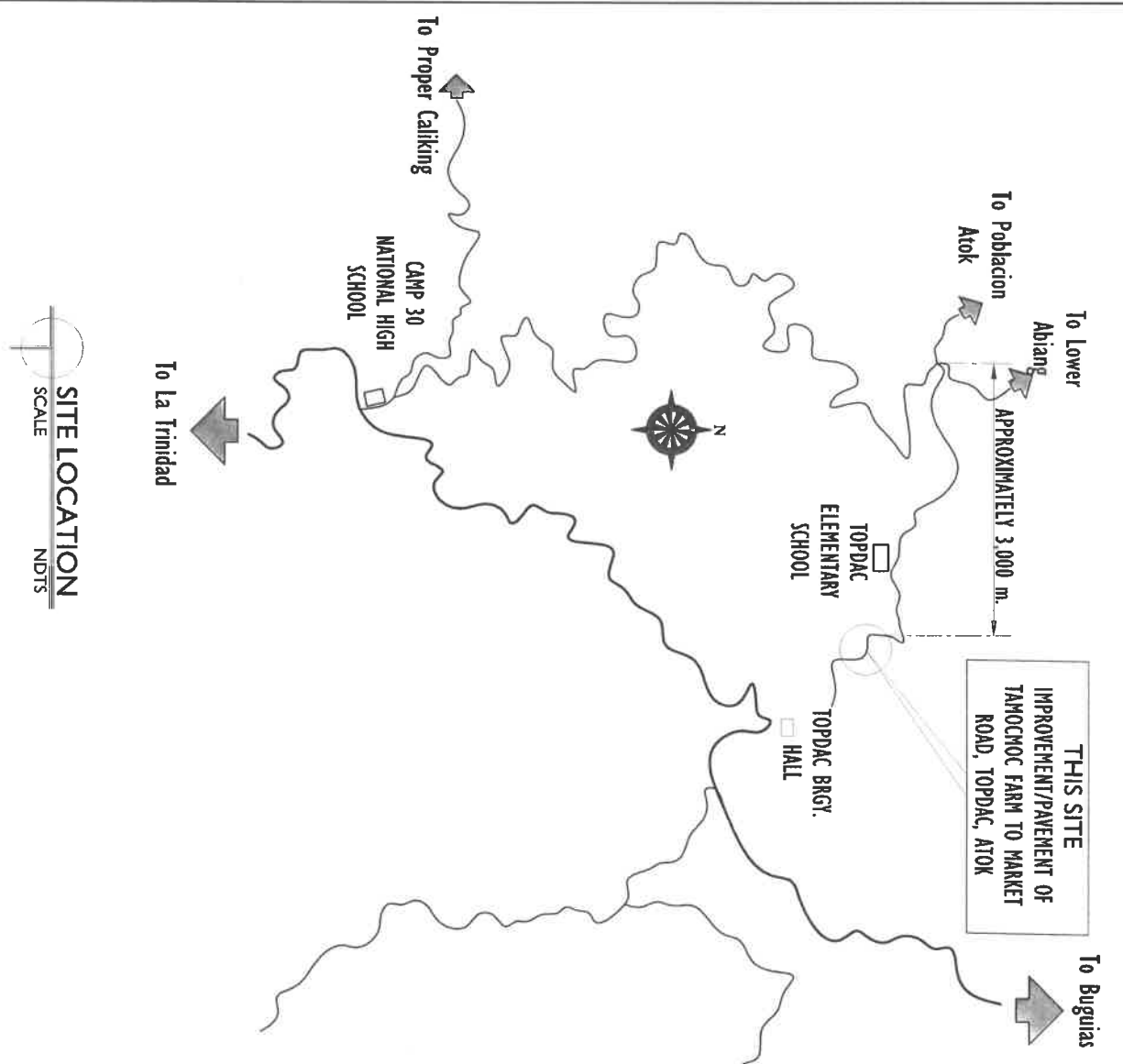

SITE LOCATION
SCALE NDT'S

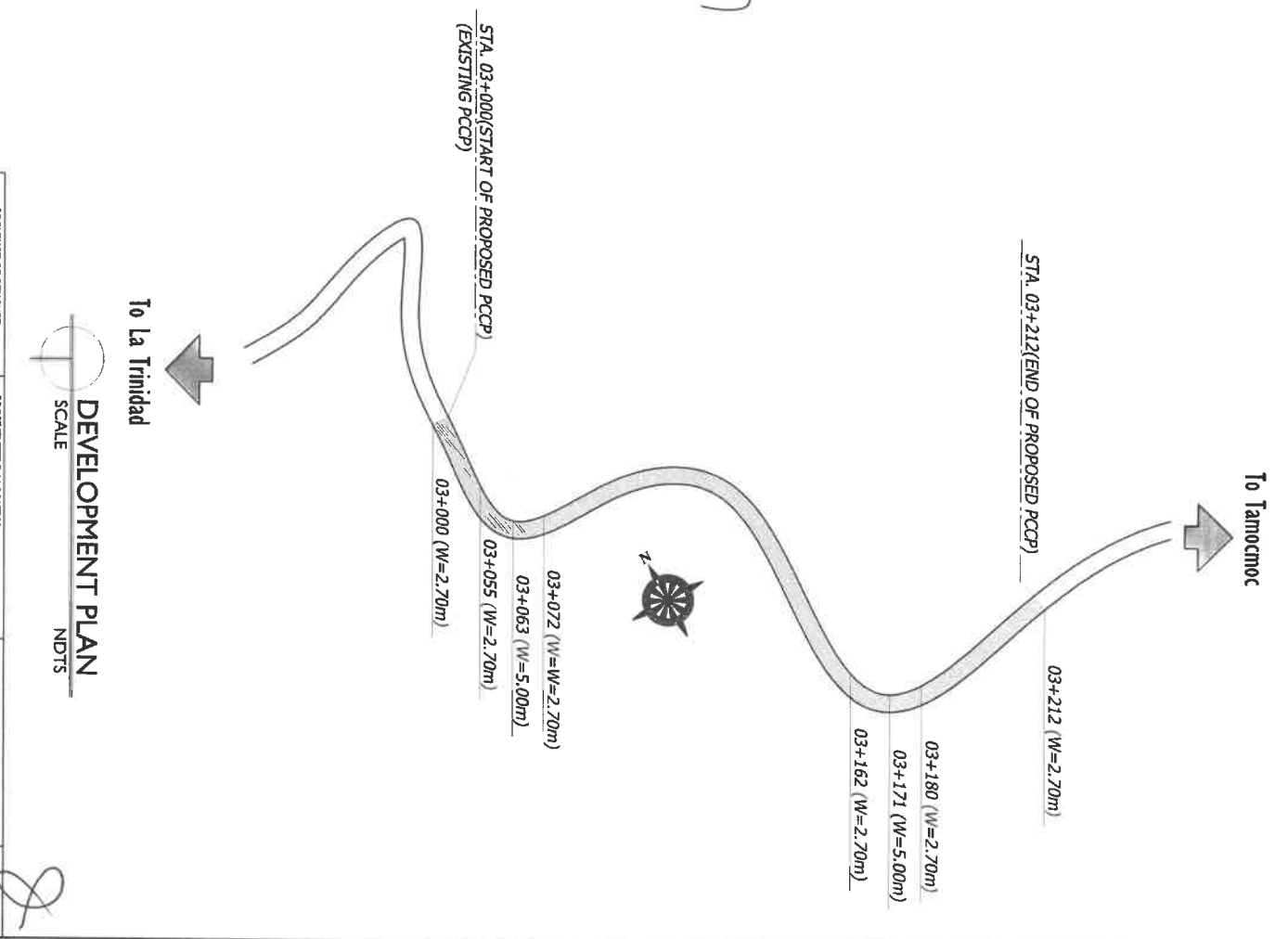

DEVELOPMENT PLAN
SCALE NDT'S

 PROVINCE OF BENGUET WANGDA, LA TRINIDAD	PROJECT TITLE / LOCATION: IMPROVEMENT/PAVEMENT OF TAMOCMOC FARM TO MARKET ROAD, TOPDAC, ATOK	PREPARED BY:  RENZELLE J. S. MIAO ENGINEER 1	
--	---	--	--

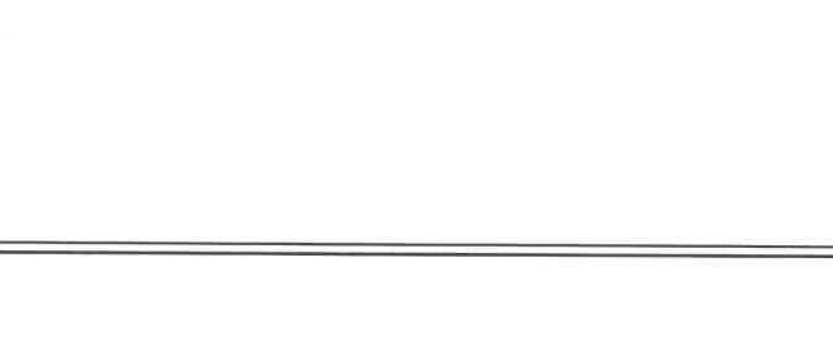
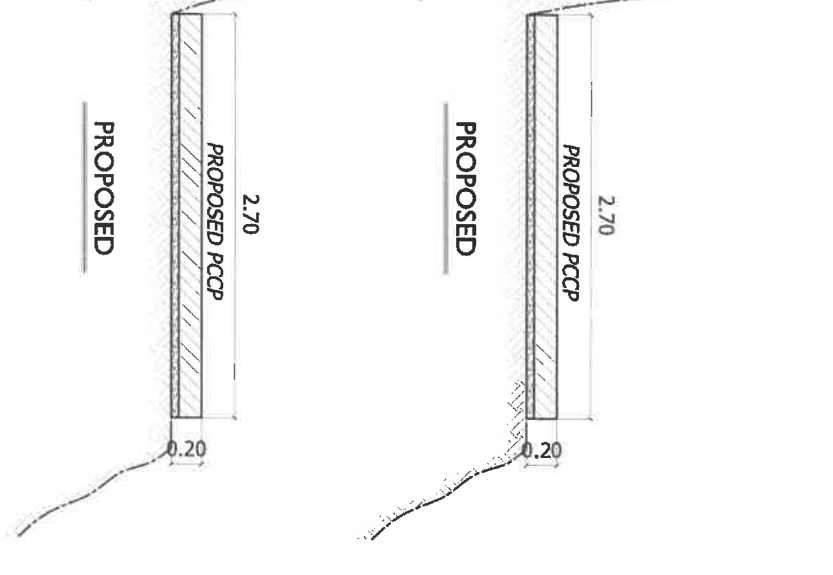
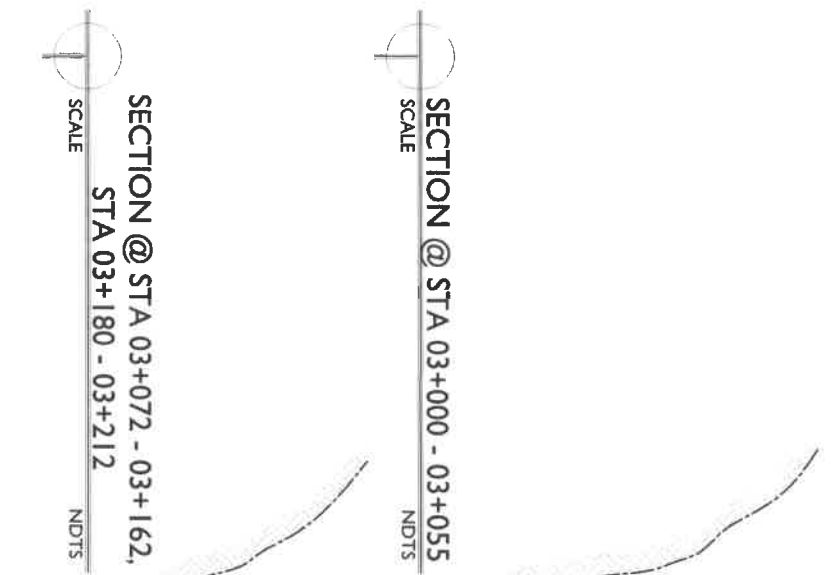
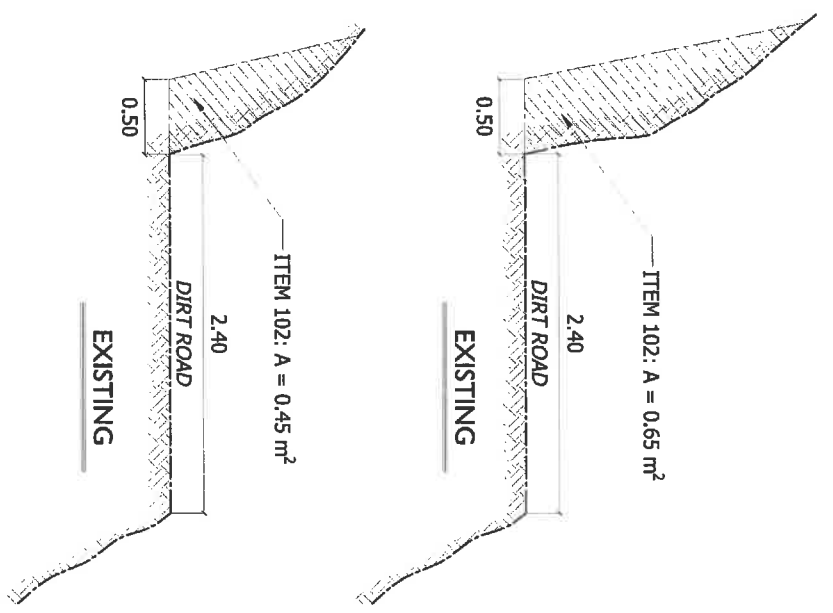



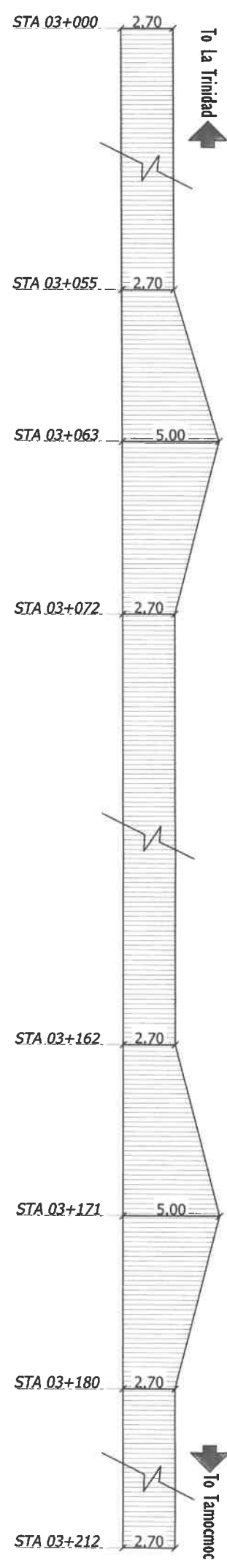

SECTION @ STA 03+000 - 03+055
SCALE
NDTS

SECTION @ STA 03+072 - 03+162,
STA 03+180 - 03+212
SCALE
NDTS



PCCP
STRAIGHT LINE DIAGRAM
SCALE
NDTS

 WANGAL, LA TRINIDAD	PROVINCE OF BENGUET PROJECT TITLE / LOCATION: IMPROVEMENT/PAVEMENT OF TAMOCMOC FARM TO MARKET ROAD, TOPDAC, ATOK	PREPARED BY:  RENELLE JAN S. MILIO ENGINEER 1
		
		

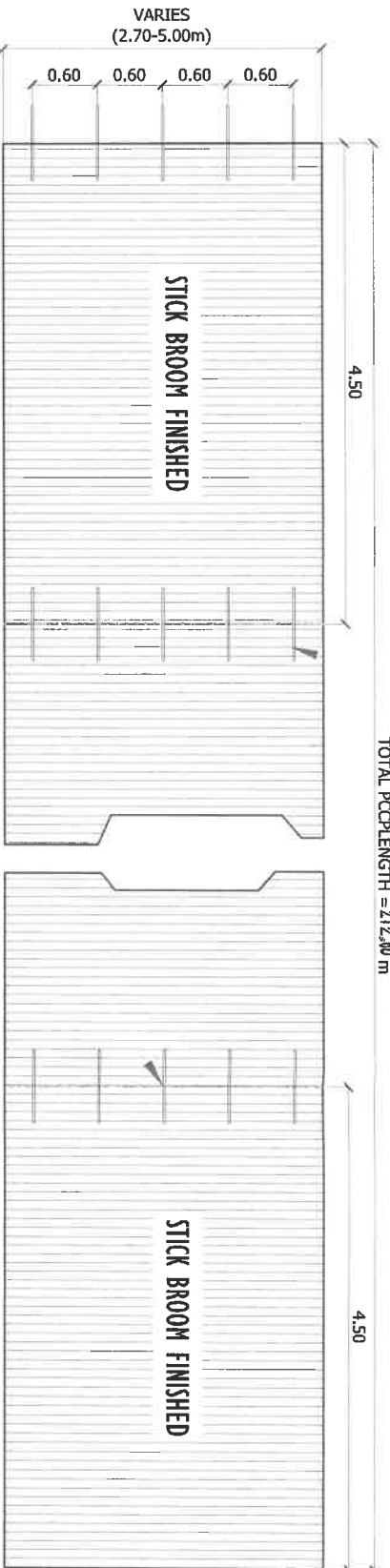

CONSTRUCTION JOINT @ EVERY END OF CONCRETE
 POURING WITH 16mm ϕ x 0.60m ROUND BAR
 DOWELS w/ 3" ϕ BLACK PVC DOWEL SLEEVE
 TOTAL PCCP LENGTH = 212.40 m

PCCP PLAN
 (STA 03+000 - 03+212)
 SCALE N/DTS

EXPANSION JOINT @ EVERY 4.50M WITH HOT ASPHALT FILLER

6mm x 50mm HOT ASPHALT FILLER

CONSTRUCTION JOINT @ EVERY END OF CONCRETE
 POURING WITH 16mm ϕ x 0.60m ROUND BAR DOWELS
 w/ 3" ϕ BLACK PVC DOWEL SLEEVE

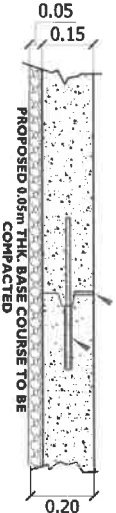

PCCP FULL WIDTH SECTION
 SCALE N/DTS

EXPANSION JOINT @ EVERY 4.50m WITH 6mm x 50mm HOT ASPHALT FILLER

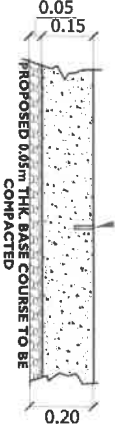

CONSTRUCTION JOINT DETAIL
 SCALE N/DTS



EXPANSION JOINT DETAIL
 SCALE N/DTS

PROVINCE OF BENGUET PBO WANGAL, LA TRINIDAD	PROJECT TITLE / LOCATION: IMPROVEMENT/PAVEMENT OF TAMOCMOC FARM TO MARKET ROAD, TOPDAC, ATOK	PREPARED BY: RENZELLE JOY S. MILLO ENGINEER 1
--	---	--

