

Philippine Bidding Documents

(As Harmonized with Development Partners)

Procurement of INFRASTRUCTURE PROJECTS

Government of the Republic of the Philippines

Sixth Edition

July 2020

PROPOSAL OF: _____

ADDRESS: _____

To be received until **8:30 AM** on **March 8, 2022** at the 2nd floor BAC Office, Capitol Building, Poblacion, La Trinidad, Benguet.

BID OPENING: 9:00 AM @ Ben Palispis Hall, Capitol Building, Poblacion, La Trinidad, Benguet

ATTY. SUNNY G. SACLA
Provincial Legal Officer

BAC-Infrastructure Chairperson

O.R. No: _____

Issued by: _____

Date: _____

TABLE OF CONTENTS

Philippine Bidding Documents	1
Section I. Invitation to Bid	4
Section II. Instructions to Bidders	7
1. Scope of Bid	7
2. Funding Information.....	7
3. Bidding Requirements	7
4. Corrupt, Fraudulent, Collusive, Coercive, and Obstructive Practices	8
5. Eligible Bidders	8
6. Origin of Associated Goods	8
7. Subcontracts	8
8. Pre-Bid Conference	8
9. Clarification and Amendment of Bidding Documents.....	9
10. Documents Comprising the Bid: Eligibility and Technical Components	9
11. Documents Comprising the Bid: Financial Component	9
12. Alternative Bids.....	10
13. Bid Prices.....	10
14. Bid and Payment Currencies	10
15. Bid Security	10
16. Sealing and Marking of Bids.....	11
17. Deadline for Submission of Bids.....	11
18. Opening and Preliminary Examination of Bids	11
19. Detailed Evaluation and Comparison of Bids	11
20. Post Qualification	12
21. Signing of the Contract.....	12
Section III. Bid Data Sheet	13
Section IV. General Conditions of Contract	15
1. Scope of Contract	15
2. Sectional Completion of Works.....	15
3. Possession of Site	15
4. The Contractor's Obligations	15
5. Performance Security	16
6. Site Investigation Reports	16
7. Warranty	16

8. Liability of the Contractor	16
9. Termination for Other Causes	17
10. Dayworks.....	17
11. Program of Work	17
12. Instructions, Inspections and Audits	17
13. Advance Payment	17
14. Progress Payments	18
15. Operating and Maintenance Manuals	18
Section V. Special Conditions of Contract	19
Section VI. Specifications	20
Section VII. Drawings	21
This Section contains the Plans and Drawings of the project from pages 1-7.....	21
Section VIII. Bill of Quantities	28
Section IX. Checklist of Technical and Financial Documents.....	29
Section X. Forms	31
I. Bid form for the Procurement of Infrastructure Project	31
II. Omnibus Sworn Statement	33
III. Contract Agreement Form for the Procurement of Infrastructure Projects	36
IV. Bid Security Declaration Form	38
V. Statement of Single Largest Completed Contract (SLCC) Similar to the Contract to be Bid.....	40

Section I. Invitation to Bid



Republic of the Philippines
PROVINCE OF BENGUET
LA TRINIDAD
BIDS AND AWARDS COMMITTEE
(Infrastructure)

INVITATION TO BID FOR THE PROJECT:

**A. CONSTRUCTION OF RETAINING WALL, NBDH; B.
CONSTRUCTION OF RETAINING WALL, NBDH, BUGUIAS -
ADDITIONAL**

1. **The Provincial Government of Benguet, through the A. GF CY 2020; B. GF CY 2022 apply the sum of A. P1,000,000.00; B. P1,000,000.00 = P2,000,000.00 being the Approved Budget for the Contract (ABC) to payments under the contract for the project: A. CONSTRUCTION OF RETAINING WALL, NBDH; B. CONSTRUCTION OF RETAINING WALL, NBDH, BUGUIAS – ADDITIONAL with PIN A. GF 20058; B. GF 22053. Bids received in excess of the ABC shall be automatically rejected at the bidding.**
2. **The Provincial Government of Benguet now invites bids for the above Procurement Project. Completion of the Work required 73'C.D. Bidders should have completed a contract similar to the project. The description of an eligible bidder is contained in the Bidding Documents, particularly, in Section II (Instructions to Bidders).**
3. **Bidding will be conducted through open competitive bidding procedures using non-discretionary "pass/fail" criterion as specified in the 2016 Revised Implementing Rules and Regulations (IRR) of Republic Act No. 9184.**
4. **Interested bidders may obtain further information from the Provincial Government of Benguet and inspect the Bidding Documents at the address given below from 8:00 o'clock in the morning to 5:00 o'clock in the afternoon. The date of posting in the PhilGEPS, Benguet Website, Provincial Engineer's Office, BAC Bulletin Board and Provincial Capitol Lobby is from FEBRUARY 15, 2022 – FEBRUARY 22, 2022.**
BAC-Infrastructure Office 2nd Floor, Capitol Building, La Trinidad, Benguet, Philippines.
5. **A complete set of Bidding Documents in a hard and soft copy (CD) may be acquired by interested bidders on FEBRUARY 15, 2022 TO MARCH 7, 2022 from the given address and upon payment of the applicable fee for the Bidding Documents, pursuant to the latest Guidelines issued by the GPPB, in the amount of Php5,000.00. The Procuring Entity shall allow the bidder to present its proof of payment for the fees presented in person.**

6. The Provincial Government of Benguet will hold a **PRE-BID CONFERENCE** on **FEBRUARY 23, 2022 at 9:00 o'clock** in the morning at the **BEN PALISPIS Hall, 3rd Floor, Capitol Building, La Trinidad, Benguet** which shall be open to all prospective bidders.
7. Bids must be duly received by the BAC Secretariat through **manual submission** at the office address as indicated below on or before **MARCH 8, 2022 at 8:30 a.m** at the **BAC-Infrastructure Office 2nd Floor, Capitol Building, La Trinidad, Benguet, Philippines**. Late bids shall not be accepted.
8. All bids must be accompanied by a bid security in any of the acceptable forms and in the amount stated in ITB Clause 15.
9. **BID OPENING** shall be on **MARCH 8, 2022 at 9:00 a.m** at the **Ben Palispis Hall, 3rd Floor, Capitol Building, La Trinidad, Benguet**. Bids will be opened in the presence of the bidder or his/her representative/s who choose to attend the activity.
10. The only authorized person to buy and drop bid documents is the bidder himself or his/her representative through a Special Power of Attorney (SPA), particularly stating therein the title of the project/s which the Principal (bidder) is granting authority for his/her agent with the power to buy, drop and sign in behalf of the principal any documents required in procurement proceedings (R.A 9184).
11. Bidding is restricted to Filipino Citizens/Sole proprietorships, or organizations with at least **Seventy-Five Percent (75%)** interests or outstanding capital stock belonging to citizens of the Philippines.
12. Detailed estimate for all Items of Work shall be itemized (Not Lump Sum) unless specified on plans.
13. The **Minimum License Required and Classification** for this project is **SMALL B-General Building**.
14. In view of the travel restrictions imposed by concerned national and local government agencies as a mitigating measure to arrest the spread of the COVID 19 virus and to facilitate the dispatching of communications/correspondence emanating from the BAC, bidders with business address located outside La Trinidad, Benguet and Baguio City, **SHALL** provide and/or indicate an address within La Trinidad, Benguet within which communications/correspondence will be sent.
15. In compliance with the recently approved GPPB Resolution No. 15-2021, dated October 14, 2021 prospective bidders are mandated to update their PhilGEPS



Certificate of Platinum Registration and Membership by uploading and entering the data in the PhilGEPS the current and updated Class "A" eligibility documents.

16. The Provincial Government of Benguet reserves the right to reject any and all bids, declare a failure of bidding, or not award the contract at any time prior to contract award in accordance with Sections 35.6 and 41 of the 2016 Revised Implementing Rules and Regulations (IRR) of RA No. 9184, without thereby incurring any liability to the affected bidder or bidders.

For further information, please refer to:

FERDINAND P. CATORES
Head, BAC Secretariat
CP No. 09108175538
Website: www.benguet.gov.ph
Email Address: bac.infra@benguet.gov.ph

February 11, 2022.

ATTY. SUNNY G. SACLA
Chairman, BAC on Infrastructure

Section II. Instructions to Bidders

1. Scope of Bid

The Procuring Entity, ***PROVINCIAL GOVERNMENT OF BENGUET*** invites Bids for the ***A. Construction of Retaining Wall, NBDH; B. Construction of Retaining Wall, NBDH, Buguias- Additional***, with Project Identification Number ***A. GF 20058; B. GF 22053.***

The Procurement Project (referred to herein as “Project”) is for the construction of Works, as described in Section VI (Specifications).

2. Funding Information

2.1. The GOP through the source of funding as indicated below for ***A. GF CY 2020; B. GF CY 2022*** in the amount of ***A. 1,000,000 + B. 1,000,000= Php 2,000,000.00***

2.2. The source of funding is:

a. LGUs, the Annual or Supplemental Budget, as approved by the Sanggunian.

3. Bidding Requirements

The Bidding for the Project shall be governed by all the provisions of RA No. 9184 and its 2016 revised IRR, including its Generic Procurement Manual and associated policies, rules and regulations as the primary source thereof, while the herein clauses shall serve as the secondary source thereof.

Any amendments made to the IRR and other GPPB issuances shall be applicable only to the ongoing posting, advertisement, or invitation to bid by the BAC through the issuance of a supplemental or bid bulletin.

The Bidder, by the act of submitting its Bid, shall be deemed to have inspected the site, determined the general characteristics of the contracted Works and the conditions for this Project, such as the location and the nature of the work; (b) climatic conditions; (c) transportation facilities; (c) nature and condition of the terrain, geological conditions at the site communication facilities, requirements, location and availability of construction aggregates and other materials, labor, water, electric power and access roads; and (d) other factors that may affect the cost, duration and execution or implementation of the contract, project, or work and examine all instructions, forms, terms, and project requirements in the Bidding Documents.

4. Corrupt, Fraudulent, Collusive, Coercive, and Obstructive Practices

The Procuring Entity, as well as the Bidders and Contractors, shall observe the highest standard of ethics during the procurement and execution of the contract. They or through an agent shall not engage in corrupt, fraudulent, collusive, coercive, and obstructive practices defined under Annex “I” of the 2016 revised IRR of RA No. 9184 or other integrity violations in competing for the Project.

5. Eligible Bidders

5.1. Only Bids of Bidders found to be legally, technically, and financially capable will be evaluated.

5.2. The Bidder must have an experience of having completed a Single Largest Completed Contract (SLCC) that is similar to this Project, equivalent to at least fifty percent (50%) of the ABC adjusted, if necessary, by the Bidder to current prices using the PSA’s CPI, except under conditions provided for in Section 23.4.2.4 of the 2016 revised IRR of RA No. 9184.

A contract is considered to be “similar” to the contract to be bid if it has the major categories of work stated in the **BDS**.

5.3. For Foreign-funded Procurement, the Procuring Entity and the foreign government/foreign or international financing institution may agree on another track record requirement, as specified in the Bidding Document prepared for this purpose.

5.4. The Bidders shall comply with the eligibility criteria under Section 23.4.2 of the 2016 IRR of RA No. 9184.

6. Origin of Associated Goods

There is no restriction on the origin of Goods other than those prohibited by a decision of the UN Security Council taken under Chapter VII of the Charter of the UN.

7. Subcontracts

a. Subcontracting is not allowed

8. Pre-Bid Conference

The Procuring Entity will hold a pre-bid conference for this Project on the specified date and time and either at its physical address as indicated in the **IB**.

9. Clarification and Amendment of Bidding Documents

Prospective bidders may request for clarification on and/or interpretation of any part of the Bidding Documents. Such requests must be in writing and received by the Procuring Entity, either at its given address or through electronic mail indicated in the **IB**, at least ten (10) calendar days before the deadline set for the submission and receipt of Bids.

10. Documents Comprising the Bid: Eligibility and Technical Components

10.1. The first envelope shall contain the eligibility and technical documents of the Bid as specified in **Section IX. Checklist of Technical and Financial Documents**.

10.2. If the eligibility requirements or statements, the bids, and all other documents for submission to the BAC are in foreign language other than English, it must be accompanied by a translation in English, which shall be authenticated by the appropriate Philippine foreign service establishment, post, or the equivalent office having jurisdiction over the foreign bidder's affairs in the Philippines. For Contracting Parties to the Apostille Convention, only the translated documents shall be authenticated through an apostille pursuant to GPPB Resolution No. 13-2019 dated 23 May 2019. The English translation shall govern, for purposes of interpretation of the bid.

10.3. A valid PCAB License is required, and in case of joint ventures, a valid special PCAB License, and registration for the type and cost of the contract for this Project. Any additional type of Contractor license or permit shall be indicated in the **BDS**.

10.4. A List of Contractor's key personnel (e.g., Project Manager, Project Engineers, Materials Engineers, and Foremen) assigned to the contract to be bid, with their complete qualification and experience data shall be provided. These key personnel must meet the required minimum years of experience set in the **BDS**.

10.5. A List of Contractor's major equipment units, which are owned, leased, and/or under purchase agreements, supported by proof of ownership, certification of availability of equipment from the equipment lessor/vendor for the duration of the project, as the case may be, must meet the minimum requirements for the contract set in the **BDS**.

11. Documents Comprising the Bid: Financial Component

11.1. The second bid envelope shall contain the financial documents for the Bid as specified in **Section IX. Checklist of Technical and Financial Documents**.

- 11.2. Any bid exceeding the ABC indicated in paragraph 1 of the **IB** shall not be accepted.
- 11.3. For Foreign-funded procurement, a ceiling may be applied to bid prices provided the conditions are met under Section 31.2 of the 2016 revised IRR of RA No. 9184.

12. Alternative Bids

Bidders shall submit offers that comply with the requirements of the Bidding Documents, including the basic technical design as indicated in the drawings and specifications. Unless there is a value engineering clause in the **BDS**, alternative Bids shall not be accepted.

13. Bid Prices

All bid prices for the given scope of work in the Project as awarded shall be considered as fixed prices, and therefore not subject to price escalation during contract implementation, except under extraordinary circumstances as determined by the NEDA and approved by the GPPB pursuant to the revised Guidelines for Contract Price Escalation guidelines.

14. Bid and Payment Currencies

14.1. Bid prices may be quoted in the local currency or tradeable currency accepted by the BSP at the discretion of the Bidder. However, for purposes of bid evaluation, Bids denominated in foreign currencies shall be converted to Philippine currency based on the exchange rate as published in the BSP reference rate bulletin on the day of the bid opening.

14.2. *Payment of the contract price shall be made in:*

- a. Philippine Pesos.

15. Bid Security

- 15.1. The Bidder shall submit an original copy of a notarized Bid Securing Declaration (BSD) or any form of Bid Security in the amount indicated in the **BDS**, which shall be not less than the percentage of the ABC in accordance with the schedule in the **BDS**.
- 15.2. The Bid and bid security shall be valid for a period of 120 days from date of opening of bids. Any bid not accompanied by an acceptable bid security shall be rejected by the Procuring Entity as non-responsive.

16. Sealing and Marking of Bids

Each Bidder shall submit one copy of the first and second components of its Bid.

The Procuring Entity may request additional hard copies and/or electronic copies of the Bid. However, failure of the Bidders to comply with the said request shall not be a ground for disqualification.

If the Procuring Entity allows the submission of bids through online submission to the given website or any other electronic means, the Bidder shall submit an electronic copy of its Bid, which must be digitally signed. An electronic copy that cannot be opened or is corrupted shall be considered non-responsive and, thus, automatically disqualified.

17. Deadline for Submission of Bids

The Bidders shall submit on the specified date and time at its physical address as indicated in of the **IB**.

18. Opening and Preliminary Examination of Bids

18.1. The BAC shall open the Bids in public at the time, on the date, and at the place specified in the **IB**. The Bidders' representatives who are present shall sign a register evidencing their attendance. In case videoconferencing, webcasting or other similar technologies will be used, attendance of participants shall likewise be recorded by the BAC Secretariat.

In case the Bids cannot be opened as scheduled due to justifiable reasons, the rescheduling requirements under Section 29 of the 2016 revised IRR of RA No. 9184 shall prevail.

18.2. The preliminary examination of Bids shall be governed by Section 30 of the 2016 revised IRR of RA No. 9184.

19. Detailed Evaluation and Comparison of Bids

19.1. The Procuring Entity's BAC shall immediately conduct a detailed evaluation of all Bids rated "*passed*" using non-discretionary pass/fail criteria. The BAC shall consider the conditions in the evaluation of Bids under Section 32.2 of 2016 revised IRR of RA No. 9184.

19.2. If the Project allows partial bids, all Bids and combinations of Bids as indicated in the **BDS** shall be received by the same deadline and opened and evaluated simultaneously so as to determine the Bid or combination of Bids offering the

lowest calculated cost to the Procuring Entity. Bid Security as required by **ITB** Clause 16 shall be submitted for each contract (lot) separately.

19.3. In all cases, the NFCC computation pursuant to Section 23.4.2.6 of the 2016 revised IRR of RA No. 9184 must be sufficient for the total of the ABCs for all the lots participated in by the prospective Bidder.

20. Post Qualification

Within a non-extendible period of five (5) calendar days from receipt by the Bidder of the notice from the BAC that it submitted the Lowest Calculated Bid, the Bidder shall submit its latest income and business tax returns filed and paid through the BIR Electronic Filing and Payment System (eFPS), and other appropriate licenses and permits required by law and stated in the **BDS**.

21. Signing of the Contract

The documents required in Section 37.2 of the 2016 revised IRR of RA No. 9184 shall form part of the Contract. Additional Contract documents are indicated in the **BDS**.

Section III. Bid Data Sheet

ITB Clause																														
5.2	<p>For this purpose, contracts similar to the Project refer to contracts which have the same major categories of work.</p> <p>The Bidder must have an experience of having completed a Single Largest Completed Contract (SLCC) that is similar to this Project, equivalent to at least fifty percent (50%) of the ABC adjusted, if necessary, by the Bidder to current prices using the PSA's CPI, except under conditions provided for in Section 23.4.2.4 of the 2016 revised IRR of RA No. 9184.</p>																													
7.1	Subcontracting is NOT allowed.																													
10.3	<p>A valid PCAB License is required, and in case of joint ventures, a valid special PCAB License, and registration for the type and cost of the contract for this Project.</p> <p>-Joint Venture Agreement (JVA), if applicable (if not applicable submit/attach a paper indicating that it is "NOT APPLICABLE" – as per supplemental Bid Bulletin No. 033-2018)</p> <p>-Special PCAB license and Registration, in case of JV (if not applicable submit/attach a paper indicating that it is "NOT APPLICABLE" – as per supplemental Bid Bulletin No. 033-2018)</p>																													
10.4	<p>The Contractor shall employ the following Key Personnel:</p> <table border="1" style="width: 100%; border-collapse: collapse; margin-bottom: 10px;"> <tbody> <tr> <td style="width: 50%;"><i>Project Engineer</i></td> <td style="width: 50%; text-align: center;">/</td> <td style="width: 50%;"><i>Laborer</i></td> <td style="width: 50%; text-align: center;">-</td> </tr> <tr> <td><i>Project Foreman</i></td> <td style="text-align: center;">/</td> <td><i>Mason</i></td> <td style="text-align: center;">-</td> </tr> <tr> <td><i>Part time Safety Practitioner</i></td> <td style="text-align: center;">/</td> <td><i>Skilled Laborer</i></td> <td style="text-align: center;">/</td> </tr> <tr> <td><i>First Aider</i></td> <td style="text-align: center;">/</td> <td></td> <td></td> </tr> <tr> <td></td> <td></td> <td></td> <td></td> </tr> </tbody> </table> <p>The key personnel must meet the required minimum years of experience set below:</p> <table style="width: 100%; border-collapse: collapse;"> <thead> <tr> <th style="text-align: left; border-bottom: 1px solid black;">Key Personnel</th> <th style="text-align: left; border-bottom: 1px solid black;">General Experience</th> <th style="text-align: left; border-bottom: 1px solid black;">Relevant Experience</th> </tr> </thead> <tbody> <tr> <td>Project Engineer</td> <td>Min. of 2 Years</td> <td>At least 2 Projects that are similar in nature</td> </tr> <tr> <td>Project Foreman</td> <td>Min. of 2 Years</td> <td>At least 2 Projects that are similar in nature</td> </tr> </tbody> </table> <p><u>NB. Use SF-INFR-46 and SF-INFR-47 for Project Engineer and Project Foreman</u></p> <p><u>FAILURE TO COMPLY SHALL BE GROUND FOR DISQUALIFICATION</u></p> <p><i>-PRC License of Engineers pledged to the Contract must be valid. A photocopy of said PRC license shall be attached as part of the bidding documents.</i></p>	<i>Project Engineer</i>	/	<i>Laborer</i>	-	<i>Project Foreman</i>	/	<i>Mason</i>	-	<i>Part time Safety Practitioner</i>	/	<i>Skilled Laborer</i>	/	<i>First Aider</i>	/							Key Personnel	General Experience	Relevant Experience	Project Engineer	Min. of 2 Years	At least 2 Projects that are similar in nature	Project Foreman	Min. of 2 Years	At least 2 Projects that are similar in nature
<i>Project Engineer</i>	/	<i>Laborer</i>	-																											
<i>Project Foreman</i>	/	<i>Mason</i>	-																											
<i>Part time Safety Practitioner</i>	/	<i>Skilled Laborer</i>	/																											
<i>First Aider</i>	/																													
Key Personnel	General Experience	Relevant Experience																												
Project Engineer	Min. of 2 Years	At least 2 Projects that are similar in nature																												
Project Foreman	Min. of 2 Years	At least 2 Projects that are similar in nature																												

10.5	<p>The minimum equipment are the following:</p> <table border="1" data-bbox="370 142 1377 579"> <thead> <tr> <th data-bbox="370 142 1260 184">Equipment</th> <th data-bbox="699 142 833 184">Capacity</th> <th data-bbox="997 142 1235 184">Number of Units</th> </tr> </thead> <tbody> <tr> <td data-bbox="370 184 1260 226">Cargo Truck (Mobilization and Demobilization)</td> <td></td> <td data-bbox="1260 184 1377 226">1</td> </tr> <tr> <td data-bbox="370 226 1260 268">Cargo Truck (2-5mt)</td> <td></td> <td data-bbox="1260 226 1377 268">1</td> </tr> <tr> <td data-bbox="370 268 1260 310">Bar Cutter</td> <td></td> <td data-bbox="1260 268 1377 310">1</td> </tr> <tr> <td data-bbox="370 310 1260 352">Bar Bender</td> <td></td> <td data-bbox="1260 310 1377 352">1</td> </tr> <tr> <td data-bbox="370 352 1260 394">Backhoe (0.28cu.m)</td> <td></td> <td data-bbox="1260 352 1377 394">1</td> </tr> <tr> <td data-bbox="370 394 1260 436">One Bagger Concrete Mixer</td> <td></td> <td data-bbox="1260 394 1377 436">1</td> </tr> <tr> <td data-bbox="370 436 1260 478">Concrete Vibrator</td> <td></td> <td data-bbox="1260 436 1377 478">1</td> </tr> <tr> <td data-bbox="370 478 1260 520">Water Truck (1000gal)</td> <td></td> <td data-bbox="1260 478 1377 520">1</td> </tr> <tr> <td data-bbox="370 520 1260 579">Minor Tools</td> <td></td> <td data-bbox="1260 520 1377 579"></td> </tr> </tbody> </table> <p>The list of contractor's equipment units pledged to the contract which are owned, leased, and/or under purchase agreements, supported by proof of ownership or certification of availability of equipment from the equipment lessor/vendor for the duration of the project. The Certificate of Registration (CR) and Official Receipts (OR) of Utility Vehicles/Cargo Trucks/Dump Trucks to be pledged to the contract shall be valid/current, non-compliance thereof shall be ground for disqualification.</p>	Equipment	Capacity	Number of Units	Cargo Truck (Mobilization and Demobilization)		1	Cargo Truck (2-5mt)		1	Bar Cutter		1	Bar Bender		1	Backhoe (0.28cu.m)		1	One Bagger Concrete Mixer		1	Concrete Vibrator		1	Water Truck (1000gal)		1	Minor Tools		
Equipment	Capacity	Number of Units																													
Cargo Truck (Mobilization and Demobilization)		1																													
Cargo Truck (2-5mt)		1																													
Bar Cutter		1																													
Bar Bender		1																													
Backhoe (0.28cu.m)		1																													
One Bagger Concrete Mixer		1																													
Concrete Vibrator		1																													
Water Truck (1000gal)		1																													
Minor Tools																															
12	No further instructions.																														
15.1	<p>The bid security shall be in the form of a Bid Securing Declaration or any of the following forms and amounts:</p> <ol style="list-style-type: none"> a. The amount of not less than Php 40, 000.00 (2%) of 2,000,000.00, if bid security is in cash, cashier's/manager's check, bank draft/guarantee or irrevocable letter of credit; b. The amount of not less than Php 100,000.00 (5%) of 2,000,000.00, if bid security is in Surety Bond. 																														
19.2	Partial bids are NOT allowed.																														
20	<p>The Bidder shall submit its latest income and business tax returns filed and paid through the BIR Electronic Filing and Payment System (eFPS). Within five (5) Calendar Days from receipt notice from the BAC.</p> <p>NOTE: The latest income and business tax returns are those within the last six months preceding the date of bid submission.</p> <p>ADDITIONAL REQUIREMENTS (for POST QUALIFICATION). To be submitted within five (5) Calendar Days from notice.</p> <ul style="list-style-type: none"> -Latest Income & Business Tax Returns -Provincial Permit -Printed copy of the Invitation to Bid @PhilGeps -Construction Schedule and S-curve,; -Manpower Schedule; -Construction Methods; -Equipment Utilization Schedule, -Construction Safety and Health Program, and other acceptable tools of project scheduling. -PERT-CPM <p>NB. May be submitted in advance.</p>																														

Section IV. General Conditions of Contract

1. Scope of Contract

This Contract shall include all such items, although not specifically mentioned, that can be reasonably inferred as being required for its completion as if such items were expressly mentioned herein. All the provisions of RA No. 9184 and its 2016 revised IRR, including the Generic Procurement Manual, and associated issuances, constitute the primary source for the terms and conditions of the Contract, and thus, applicable in contract implementation. Herein clauses shall serve as the secondary source for the terms and conditions of the Contract.

This is without prejudice to Sections 74.1 and 74.2 of the 2016 revised IRR of RA No. 9184 allowing the GPPB to amend the IRR, which shall be applied to all procurement activities, the advertisement, posting, or invitation of which were issued after the effectivity of the said amendment.

2. Sectional Completion of Works

If sectional completion is specified in the **Special Conditions of Contract (SCC)**, references in the Conditions of Contract to the Works, the Completion Date, and the Intended Completion Date shall apply to any Section of the Works (other than references to the Completion Date and Intended Completion Date for the whole of the Works).

3. Possession of Site

- 4.1. The Procuring Entity shall give possession of all or parts of the Site to the Contractor based on the schedule of delivery indicated in the **SCC**, which corresponds to the execution of the Works. If the Contractor suffers delay or incurs cost from failure on the part of the Procuring Entity to give possession in accordance with the terms of this clause, the Procuring Entity's Representative shall give the Contractor a Contract Time Extension and certify such sum as fair to cover the cost incurred, which sum shall be paid by Procuring Entity.
- 4.2. If possession of a portion is not given by the above date, the Procuring Entity will be deemed to have delayed the start of the relevant activities. The resulting adjustments in contract time to address such delay may be addressed through contract extension provided under Annex "E" of the 2016 revised IRR of RA No. 9184.

4. The Contractor's Obligations

The Contractor shall employ the key personnel named in the Schedule of Key Personnel indicating their designation, in accordance with **ITB** Clause 10.3 and specified in the **BDS**, to carry out the supervision of the Works.

The Procuring Entity will approve any proposed replacement of key personnel only if their relevant qualifications and abilities are equal to or better than those of the personnel listed in the Schedule.

5. Performance Security

- 5.1. Within ten (10) calendar days from receipt of the Notice of Award from the Procuring Entity but in no case later than the signing of the contract by both parties, the successful Bidder shall furnish the performance security in any of the forms prescribed in Section 39 of the 2016 revised IRR.
- 5.2. The Contractor, by entering into the Contract with the Procuring Entity, acknowledges the right of the Procuring Entity to institute action pursuant to RA No. 3688 against any subcontractor be they an individual, firm, partnership, corporation, or association supplying the Contractor with labor, materials and/or equipment for the performance of this Contract.

6. Site Investigation Reports

The Contractor, in preparing the Bid, shall rely on any Site Investigation Reports referred to in the **SCC** supplemented by any information obtained by the Contractor.

7. Warranty

- 7.1. In case the Contractor fails to undertake the repair works under Section 62.2.2 of the 2016 revised IRR, the Procuring Entity shall forfeit its performance security, subject its property(ies) to attachment or garnishment proceedings, and perpetually disqualify it from participating in any public bidding. All payables of the GOP in his favor shall be offset to recover the costs.
- 7.2. The warranty against Structural Defects/Failures, except that occasioned-on force majeure, shall cover the period from the date of issuance of the Certificate of Final Acceptance by the Procuring Entity. Specific duration of the warranty is found in the **SCC**.

8. Liability of the Contractor

Subject to additional provisions, if any, set forth in the **SCC**, the Contractor's liability under this Contract shall be as provided by the laws of the Republic of the Philippines.

If the Contractor is a joint venture, all partners to the joint venture shall be jointly and severally liable to the Procuring Entity.

9. Termination for Other Causes

Contract termination shall be initiated in case it is determined *prima facie* by the Procuring Entity that the Contractor has engaged, before, or during the implementation of the contract, in unlawful deeds and behaviors relative to contract acquisition and implementation, such as, but not limited to corrupt, fraudulent, collusive, coercive, and obstructive practices as stated in **ITB Clause 4**.

10. Dayworks

Subject to the guidelines on Variation Order in Annex "E" of the 2016 revised IRR of RA No. 9184, and if applicable as indicated in the **SCC**, the Day works rates in the Contractor's Bid shall be used for small additional amounts of work only when the Procuring Entity's Representative has given written instructions in advance for additional work to be paid for in that way.

11. Program of Work

11.1. The Contractor shall submit to the Procuring Entity's Representative for approval the said Program of Work showing the general methods, arrangements, order, and timing for all the activities in the Works. The submissions of the Program of Work are indicated in the **SCC**.

11.2. The Contractor shall submit to the Procuring Entity's Representative for approval an updated Program of Work at intervals no longer than the period stated in the **SCC**. If the Contractor does not submit an updated Program of Work within this period, the Procuring Entity's Representative may withhold the amount stated in the **SCC** from the next payment certificate and continue to withhold this amount until the next payment after the date on which the overdue Program of Work has been submitted.

12. Instructions, Inspections and Audits

The Contractor shall permit the GOP or the Procuring Entity to inspect the Contractor's accounts and records relating to the performance of the Contractor and to have them audited by auditors of the GOP or the Procuring Entity, as may be required.

13. Advance Payment

The Procuring Entity shall, upon a written request of the Contractor which shall be submitted as a Contract document, make an advance payment to the Contractor in an amount not exceeding fifteen percent (15%) of the total contract price, to be made in lump sum, or at the most two installments according to a schedule specified in the **SCC**, subject to the requirements in Annex "E" of the 2016 revised IRR of RA No. 9184.

14. Progress Payments

The Contractor may submit a request for payment for Work accomplished. Such requests for payment shall be verified and certified by the Procuring Entity's Representative/Project Engineer. Except as otherwise stipulated in the **SCC**, materials and equipment delivered on the site but not completely put in place shall not be included for payment.

15. Operating and Maintenance Manuals

15.1. If required, the Contractor will provide "as built" Drawings and/or operating and maintenance manuals as specified in the **SCC**.

15.2. If the Contractor does not provide the Drawings and/or manuals by the dates stated above, or they do not receive the Procuring Entity's Representative's approval, the Procuring Entity's Representative may withhold the amount stated in the **SCC** from payments due to the Contractor.

Section V. Special Conditions of Contract

GCC Clause	
2	The Intended Completion Date is <u>Seventy Three (73)</u> calendar days from receipt of Notice to Proceed/start of project.
4.1	The Site is located at Municipality of <u>Buguias</u> , in the Province of <u>Benquet</u> and is defined in (refer to plan) of Section VII of the Bid Documents.
6	The site investigation reports are: refer to General Notes and Specifications and Drawings.
7.2	[In case of semi-permanent structures, such as buildings of types 1, 2, and 3 as classified under the National Building Code of the Philippines, concrete/asphalt roads, concrete river control, drainage, irrigation lined canals, river landing, deep wells, rock causeway, pedestrian overpass, and other similar semi-permanent structures:] <u>Five (5) years.</u>
10	Day works are applicable at the rate shown in the Contractor's original Bid.
11.1	The Contractor shall submit the Program of Work to the Procuring Entity's Representative within thirty (30) days of delivery of the Notice of Award.
11.2	The amount to be withheld for late submission of an updated Program of Work is 0.10% of the Contract Amount.
13	The amount of the advance payment is fifteen percent (15%) of the contract amount. Advance payment shall be made within seven (7) working days after receipt of the request from the contractor.
14	Materials and equipment delivered on the site but not completely put in place shall be included for payment.
15.1	The date by which "as built" drawings are required is within fifteen (15) calendar days from completion of the project.
15.2	The amount to be withheld for failing to produce "as built" drawings and/or operating and maintenance manuals by the date required is 0.10% of the Contract Amount.

Section VI. Specifications

- *Please refer to the General Notes in the Plans/ Drawings*

Section VII. Drawings

This Section contains the Plans and Drawings of the project from pages 1-7.

GENERAL NOTE.

A. SCOPE OF WORK

1. P.L. FABRICATION & INSTALLATION OF PROJECT BILLBOARD.
2. P.L. & CONSTRUCTION HEALTH AND SAFETY REQUIREMENTS
3. P.L. MOBILIZATION AND DEMOBILIZATION
4. ITEM 103: STRUCTURE EXCAVATION (classified Material)
5. ITEM 404: REINFORCING STEEL
6. ITEM 405: STRUCTURAL CONCRETE (Class "A" 1:2:3:4 @ 3000PSI @ 28 days)
Footings (Column, Beam, and Reinforced Concrete Piercap)
7. ITEM 505(G): GROUTED ANCHOR (Class B)

B. EQUIPMENTS TO BE USED

1. ONE UNIT - CARGO TRUCK (Mobilization and Demobilization)
2. ONE UNIT - CARGO TRUCK (2.5MT)
3. ONE UNIT - BAR CUTTER
4. ONE UNIT - BAR BENDER
5. ONE UNIT - 1 BAGGER CONCRETE MIXER
6. ONE UNIT - CONCRETE VIBRATOR
7. ONE UNIT - WATER TRUCK (1000GAL)
8. ONE UNIT - BACKHOE (0.28CUM)
9. MINOR TOOLS

C. SPECIFICATIONS

1) GENERAL

1. PROJECT BILLBOARD SHALL BE STRICTLY COMPLETED PRIOR TO THE START OF THE PROJECT.
2. ALL DIMENSIONS HEREIN ARE IN METERS UNLESS OTHERWISE SPECIFIED.
3. WORKMANSHIP SHALL CONFORM TO THE STANDARDS OF THE RESPECTIVE TRADE.
4. APPROVED METHODS HAVE DONE HEREIN TO SUIT EXISTING FIELD CONDITIONS.
5. OTHER DETAILS NOT SHOWN HEREIN OR NOT CLEARLY UNDERSTOOD SHALL BE REFERRED TO THE PROJECT IN CHARGE FOR PROPER VERIFICATION AND RECOMMENDATIONS.
6. PROHIBIT TRAFFIC / WARNING SIGNS AS SAFETY MEASURES.
7. AGGREGATES SHALL BE STRICTLY TAKEN FROM THE PROGRAMMED SOURCE.
8. IMPLEMENTATION OF CONSTRUCTION HEALTH AND SAFETY REQUIREMENTS (COSH) SHALL BE STRICTLY COMPLIED. WEARING OF PERSONAL PROTECTIVE EQUIPMENT (PPE) IS A MUST DURING THE START OF PROJECT. DESIGNATE SAFETY OFFICER AND FIRST AIDER ON SITE.

*MINIMUM PERSONAL PROTECTIVE EQUIPMENT (PPE) FOR COSH

- a. Safety Shoes
- b. Helmet / Hard Guard
- c. Safety Goggles
- d. Neck/shoulder Vest
- e. First Aid Kit
- f. 50th Approved Face Mask
- g. Medical Kits (Sanitizer, Alcohol, Thermal Scanner, Etc.)

2) REINFORCING STEEL

1. REINFORCING STEEL BARS TO BE USED SHALL CONFORM TO NEW BULET STEEL (STRUCTURAL GRADE) OF GOOD QUALITY, MEETING ALL THE REQUIREMENT OF THE STANDARD SPECIFICATIONS FOR REINFORCING BARS, AND THE SIZE REQUIRED BY THE DRAWING (φ=75mm; C=40)
2. THE LENGTH OF LAP JOINT AND ANCHORAGE SHALL NOT BE LESS THAN 40 TIMES THE DIAMETER OF THE BAR BUT NOT LESS THAN 300mm.

3) STRUCTURAL CONCRETE

1. AGGREGATES TO BE USED HEREIN SHALL BE HARD, DURABLE, CLEAN AND FREE FROM HARMFUL MATTERS THAT ARE HARMFUL TO CONCRETE.
2. CONCRETE MIXTURE FOR STRUCTURAL CONCRETE AND ALL REINFORCED STRUCTURES SHALL BE CLASS "A" (1:2:3) FC=3000PSI @ 28 DI.
3. PROVIDE ENOUGH FORM SUPPORT AND SCAFFOLDINGS FOR STRUCTURAL CONCRETE PRIOR TO CONCRETE POURING TO AVOID BREAKING & BULGING OF STRUCTURES.

4) GROUTED ANCHOR

1. STONE BODIES FOR GROUTED ANCHOR SHALL BE HARD, DURABLE AND SHALL PASS QUALITY CONTROL STANDARDS.
2. HORIZONTAL HORIZONTAL FOR GROUTED ANCHOR SHALL BE CLASS "B" (1:2)
3. GROUTED ANCHOR SHALL BE PROVIDED W/ 3" DIA. PVC PIPE. WEERHOLES SPACED AT 1.0M O.C. ON SPACERED BARS.
4. THE HORIZONTAL AND VERTICAL CONTACT SURFACE BETWEEN STONES SHALL BE EMBEDDED BY CEMENT MORTAR MIXING A MINIMUM THICKNESS OF 20MM. SUFFICIENT MORTAR SHALL BE USED TO COMPLETELY FILL ALL JOINTS LEAVING THE FACE OF THE STONES EXPOSED.

PROVINCE OF BENGUET	PROJECT TITLE/LOCATION:	PREPARED BY:	CHECKED BY:	REVIEWED BY:	APPROVAL RECOMMENDED BY:	APPROVED BY:	SHEET NO.:
	9) CONSTRUCTION OF RETAINING WALL, NBDH	SHANE D. ANASAN ENGINEERING ASSISTANT	ENR. JERRY L. BOCANOG PROVINCIAL ENGINEER	ENR. JERRY L. BOCANOG PROVINCIAL ENGINEER	MELCHOR D. BICLAS JR. PROVINCIAL GOVERNOR		1 7
WANGAL LA TRINIDAD	b) CONSTRUCTION OF RETAINING WALL, NBDH, BUGUIAS-ADDITIONAL	ENR. JERRY L. BOCANOG ENGINEERING ASSISTANT	ENR. JERRY L. BOCANOG PROVINCIAL ENGINEER	ENR. JERRY L. BOCANOG PROVINCIAL ENGINEER	MELCHOR D. BICLAS JR. PROVINCIAL GOVERNOR		

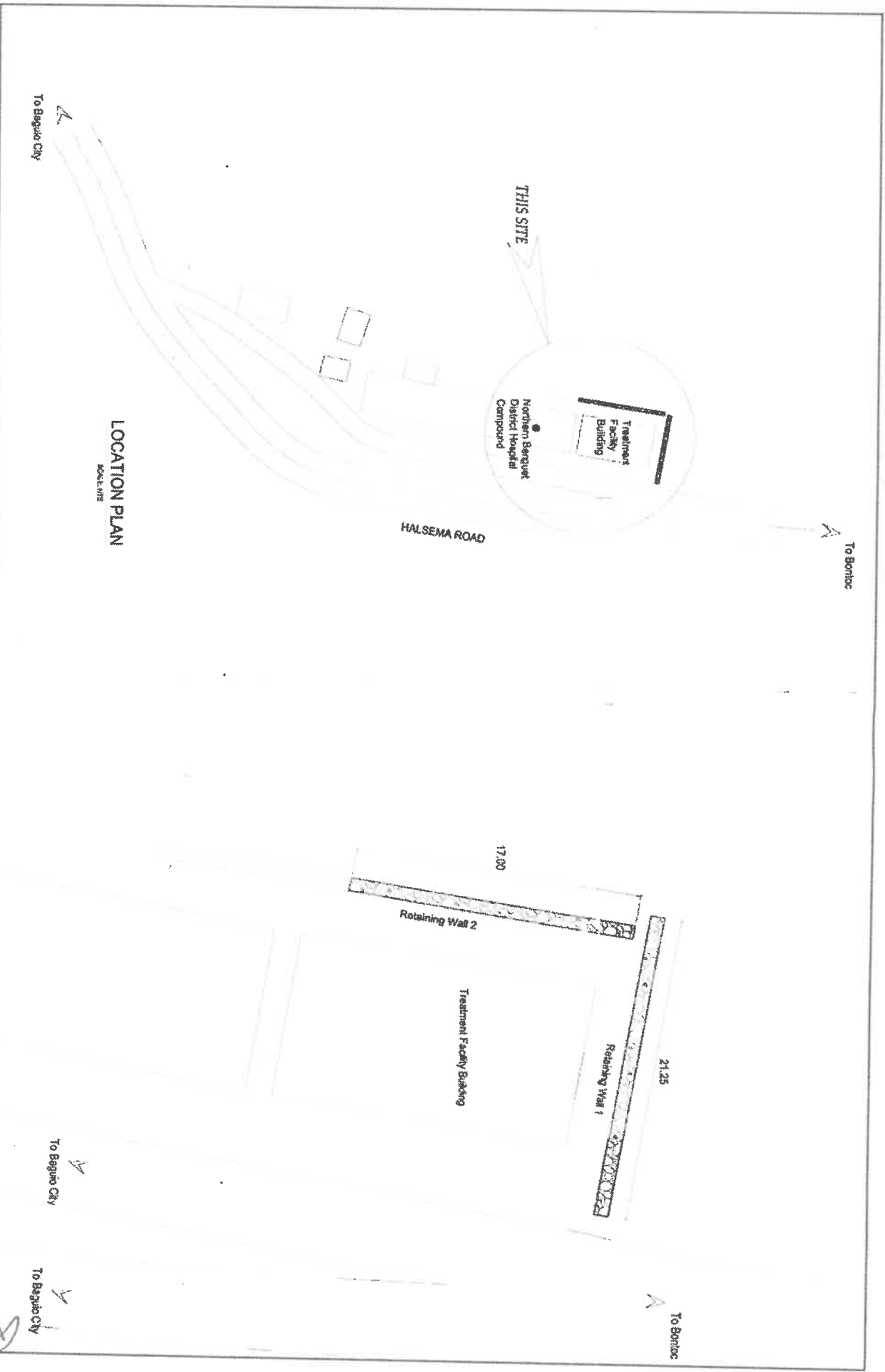

PROVINCE OF BANGUET	PROJECT TITLE/LOCATION:	PREPARED BY:
PBO	a) CONSTRUCTION OF RETAINING WALL, NBDH	<i>[Signature]</i> SHANE D. ANASAN ENGINEERING ASSISTANT
	b) CONSTRUCTION OF RETAINING WALL, NBDH, BUGUIAS-ADDITIONAL	
WANGAL, LA TRINIDAD	BUGUIAS, BANGUET	

0
1

SITE DEVELOPMENT PLAN
SCALE: 1/8"

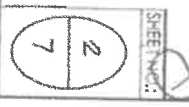

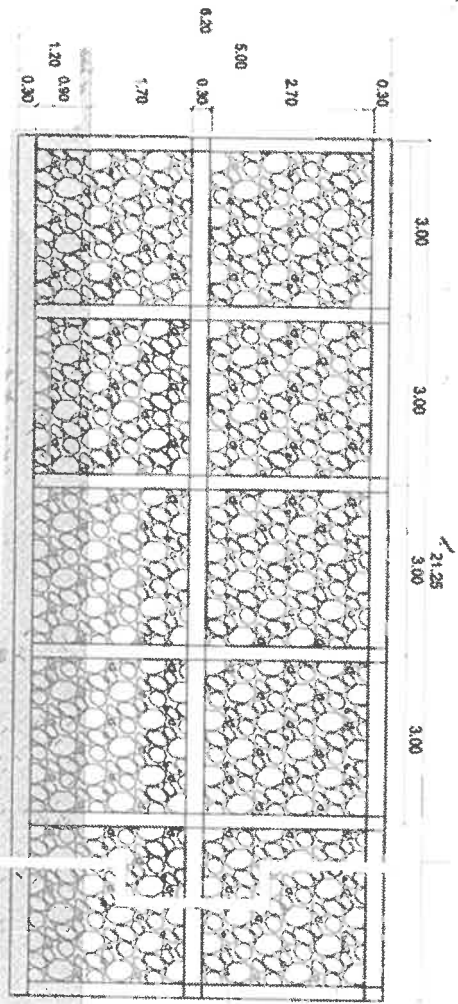

RETAINING WALL 1 ELEVATION

3" Dia. PVC Pipe(BLACK)
Spaced @ 1.0 meter on
Center on a Staggered Basis

GROUTED RIRRAP W/ RC
FOOTINGS, COLUMNS & BEAMS

NOTE:
THE HORIZONTAL AND VERTICAL CONTACT
SURFACE BETWEEN STONES SHALL BE
EMBEDDED BY GHEBET MORTAR HAVING A
MINIMUM THICKNESS OF 20MM. SUFFICIENT
MORTAR SHALL BE
USED TO COMPLETELY FILL ALL VOIDS
LEAVING THE FACE OF
THE STONES EXPOSED

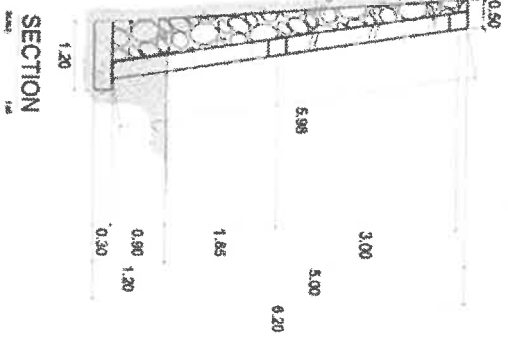

PROVINCE OF BENGUET

PRO

PROJECT TITLE/LOCATION:
d) CONSTRUCTION OF RETAINING
WALL, NBDH
b) CONSTRUCTION OF RETAINING
WALL, NBDH,
BUGUIAS-ADDITIONAL
BUGUIAS, BENGUET

PREPARED BY:

SHANE D. AMASAN
ENGINEERING ASSISTANT

WANGAL, LA TRINIDAD

7

SHEET NO.:
3/7

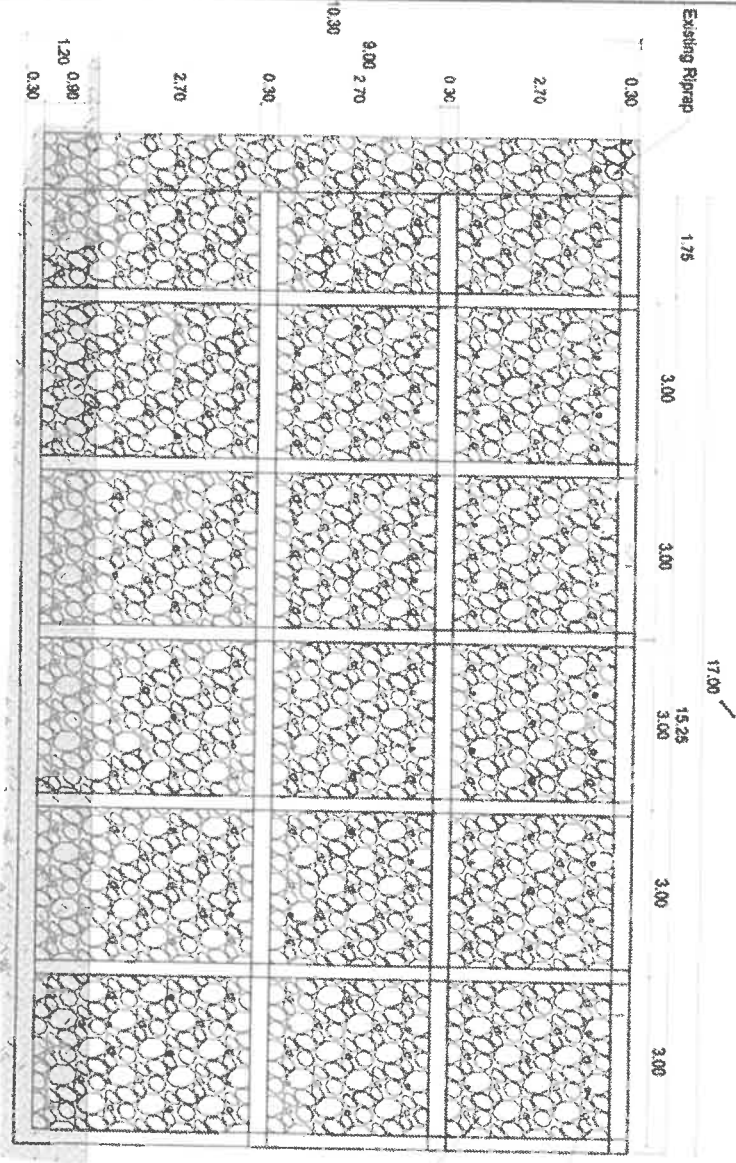

RETAINING WALL 2 ELEVATION

GRAVELLED RIPRAP W/ RC FOOTINGS, COLUMNS & BEAMS
 NOTE: THE HORIZONTAL AND VERTICAL CONTACT SURFACE BETWEEN STONES SHALL BE EMBEDDED BY CEMENT MORTAR HAVING A MINIMUM THICKNESS OF 20MM. SUFFICIENT MORTAR SHALL BE USED TO COMPLETELY FILL ALL VOIDS LEAVING THE FACE OF THE STONES EXPOSED

3" Dia. PVC Pipe(BLACK)
 Spaced @ 1.0 meter on Center on a Staggered Base

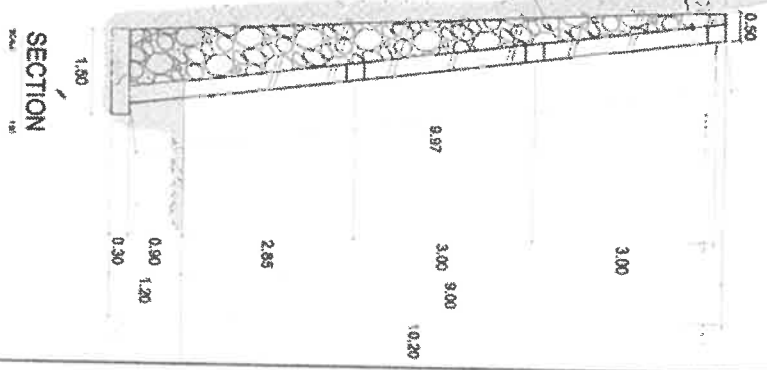

PROVINCE OF BENGUET
 PROJECT TITLE/LOCATION:
 a) CONSTRUCTION OF RETAINING WALL, NBDH
 b) CONSTRUCTION OF RETAINING WALL, NBDH, BUGUIAS-ADDITIONAL BUGUIAS, BENGUET

PREPARED BY:
 SHANE D. ANASAN
 ENGINEERING ASSISTANT

Signature of Shane D. Anasan

SHEET NO.: 4/7



PROVINCE OF BENGUET		PROJECT TITLE/LOCATION:	
PBO		a) CONSTRUCTION OF RETAINING WALL, NBDH	
WANGAL, LA TRINIDAD		b) CONSTRUCTION OF RETAINING WALL, NBDH, BUGUIAS-ADDITIONAL	
		PREPARED BY:	
		SHANE D. AMASAN ENGINEERING ASSISTANT	

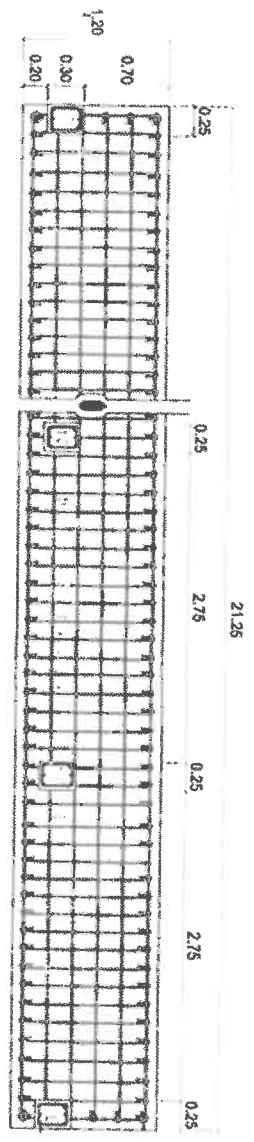

RETAINING WALL 1 FOOTING

Spec: 16mm ϕ Long RSB
Spaced as shown and
D16mm Transverse RSB
Spaced @ 0.20 OC.
Spec: 16mm ϕ Main RSB
w/ 10mm ϕ Lateral Tie
Spaced @ 0.20 OC.

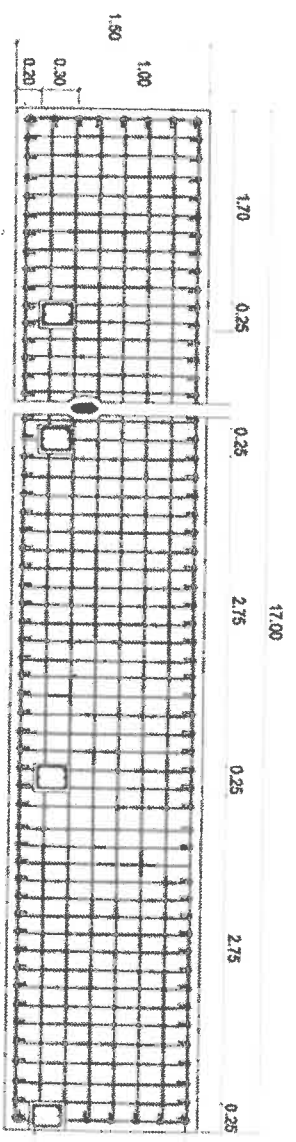

RETAINING WALL 2 FOOTING

Spec: 16mm ϕ Long RSB
Spaced as shown and
D16mm Transverse RSB
Spaced @ 0.20 OC.
Spec: 16mm ϕ Main RSB
w/ 10mm ϕ Lateral Tie
Spaced @ 0.20 OC.

SHEET NO.: 5/7

PROVINCE OF BENGUET PBO		PROJECT TITLE/LOCATION: d) CONSTRUCTION OF RETAINING WALL, NBDH		PREPARED BY: 	
WANGAL, LA TRINIDAD		b) CONSTRUCTION OF RETAINING WALL, NBDH, BUGUIAS-ADDITIONAL		SHANE D. AMASAN ENGINEERING ASSISTANT	

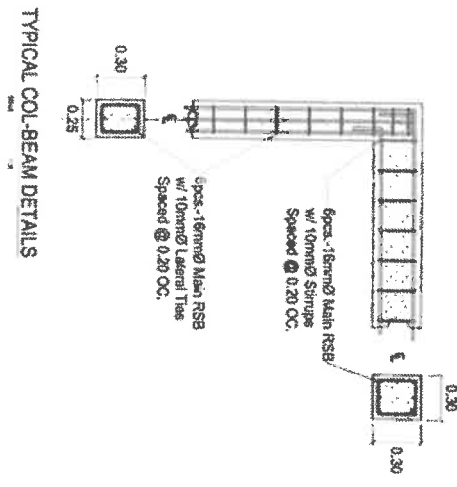

- a) Grouted Riprap 1
6pcs.-16mmØ Long. RSB Spaced as shown;
- b) Grouted Riprap 2
8pcs.-16mmØ Long. RSB Spaced as shown; and 106mm Transverse RSB Spaced @ 0.20 OC.

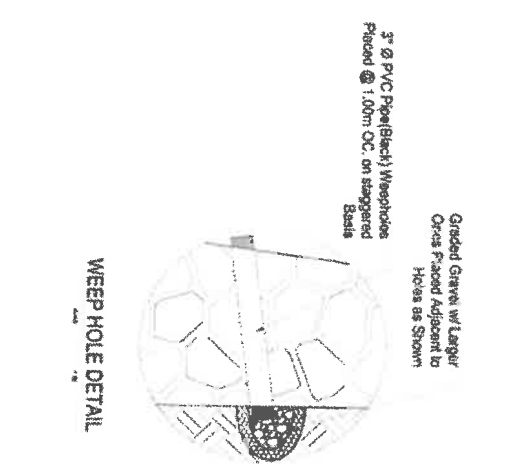
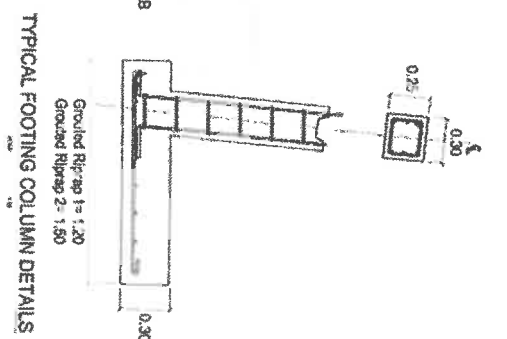

SHEET NO.:

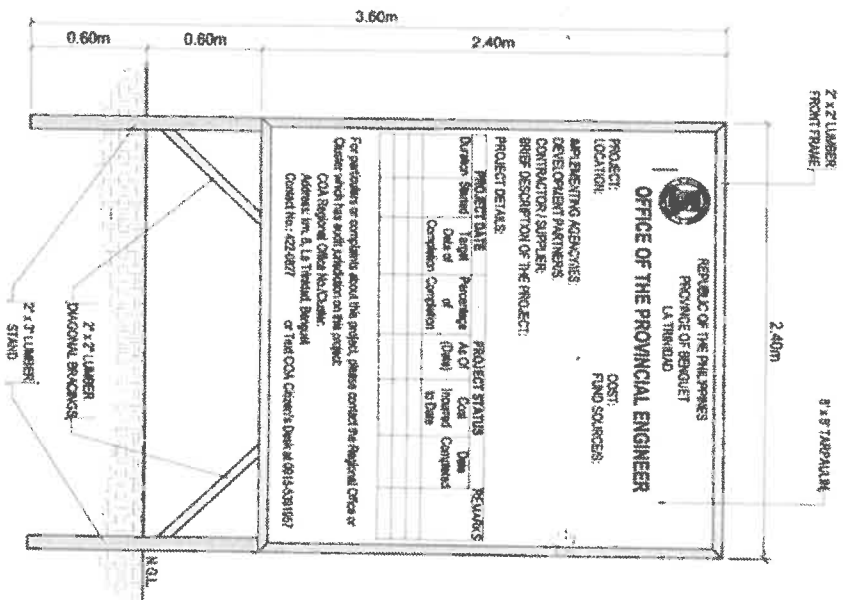

6
 7

2" x 2" LUMBER FRONT FRAME;
8' x 8' TAPERALUM

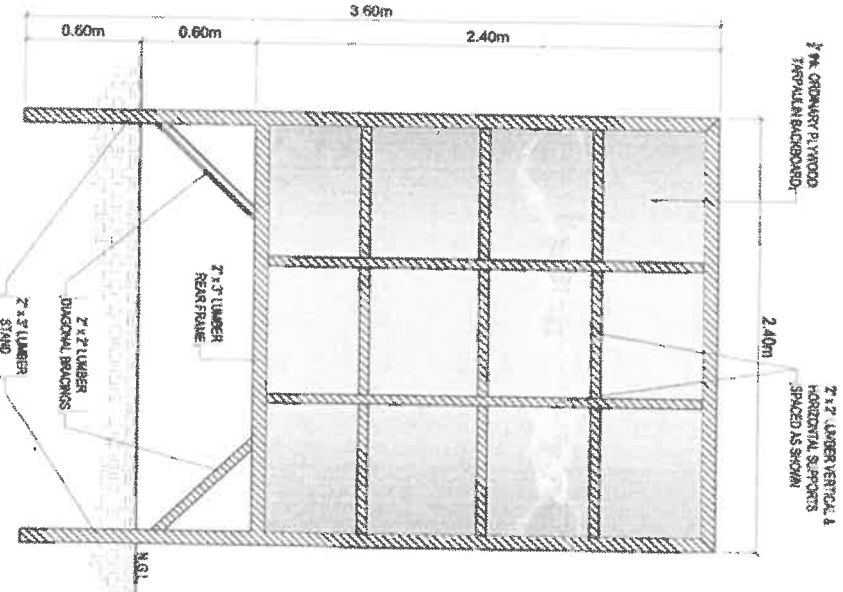

FRONT ELEVATION

3/4" OSB OR GYPSUM PL. LYING ON 7/8" PALLAN BACKBOARD;
2" x 2" LUMBER VERTICAL & HORIZONTAL SUPPORTS SPACED AS SHOWN



REAR ELEVATION

2" x 2" LUMBER SIDE FRAME;
2" x 2" LUMBER STAND

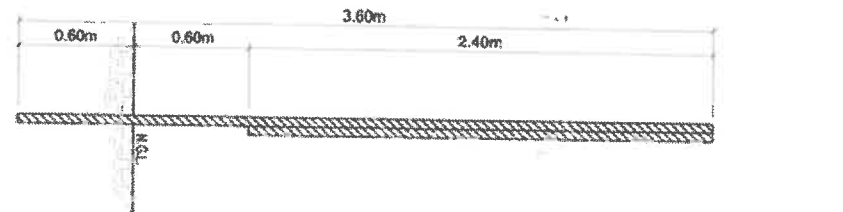

SIDE ELEVATION

NOTE:
TAPPAALUM : WHITE - 8FT x 8FT
RESOLUTION : 70 dpi
FONT : HELVETICA
FONT SIZE : MAIN INFORMATION - 3"
SUB- INFORMATION : 1"
FONT COLOR : BLACK

PROPOSED PROJECT BILLBOARD w/ STAND

NOT DRAWN TO SCALE

PROVINCE OF BENGUET
PROJECT TITLE/LOCATION:
d) CONSTRUCTION OF RETAINING WALL, NBDH



b) CONSTRUCTION OF RETAINING WALL, NBDH, BUGUIAS-ADDITIONAL BUGUIAS, BENGUET

PREPARED BY:

ENGR. SHANE D. ANASAN
ENGINEERING ASSISTANT

WANGAL, LA TRINIDAD

SHEET NO.:



Section VIII. Bill of Quantities

Provincial Government of Benguet

Standard Form Number SF-INFR - 55

Revised on: August 11, 2014

BILL OF QUANTITIES

Project Duration: 73 Calendar days

A. CONSTRUCTION OF RETAINING WALL, NBDH; B. CONSTRUCTION OF RETAINING WALL, NBDH, BUGUIAS - ADDITIONAL BUGUIAS, BENGUET

(Name & Location of Contract)

Item	Description	Unit	Quantity	Unit Price	Amount
Spl. A	Project Billboard	whole	whole		
Spl. B	Construction Health and Safety Requirements	whole	whole		
Spl. C	Mobilization and Demobilization	whole	whole		
103	Structure Excavation (Unclassified Materials)	cu.m	61.20		
404	Reinforcing Steel Bar	kgs	3759.19		
405	Structural Concrete	cu.m	31.03		
505(6)	Grouted Riprap (Class B)	cu.m	229.88		
Total Bid price:					
(In words)				(In Figure)	

Submitted by:

Date:

(Name of Bidders Representative)

(Position)

(Name of Bidders)

Section IX. Checklist of Technical and Financial Documents

(As amended by GPPB Res. No. 15-2021, dated 14, October 2021)

I. TECHNICAL COMPONENT ENVELOPE

Class "A" Documents

Legal Documents

- (a) Valid PhilGEPS Registration Certificate (Platinum Membership) (all pages) in accordance with Section 8.5.2 of the IRR;

Technical Documents

- (b) Statement of the prospective bidder of all its ongoing government and private contracts, including contracts awarded but not yet started, if any, whether similar or not similar in nature and complexity to the contract to be bid; **and**
- (c) Statement of the bidder's Single Largest Completed Contract (SLCC) similar to the contract to be bid, except under conditions provided under the rules; **and**
- (d) Special PCAB License in case of Joint Ventures; **and** registration for the type and cost of the contract to be bid; **and**
- (e) Original copy of Bid Security. If in the form of a Surety Bond, submit also a certification issued by the Insurance Commission; **or**
Original copy of Notarized Bid Securing Declaration; **and**
- (f) Project Requirements, which shall include the following:
 - a. Organizational chart for the contract to be bid;
 - b. List of contractor's key personnel (e.g., Project Manager, Project Engineers, Materials Engineers, and Foremen), to be assigned to the contract to be bid, with their complete qualification and experience data;
 - c. List of contractor's major equipment units, which are owned, leased, and/or under purchase agreements, supported by proof of ownership or certification of availability of equipment from the equipment lessor/vendor for the duration of the project, as the case may be; **and**
- (g) Original duly signed Omnibus Sworn Statement (OSS); **and** if applicable, Original Notarized Secretary's Certificate in case of a corporation, partnership, or cooperative; or Original Special Power of Attorney of all members of the joint venture giving full power and authority to its officer to sign the OSS and do acts to represent the Bidder.

Financial Documents

- (h) The prospective bidder's computation of Net Financial Contracting Capacity (NFCC).

Class "B" Documents

- (i) If applicable, duly signed joint venture agreement (JVA) in accordance with RA No. 4566 and its IRR in case the joint venture is already in existence;
or
Duly notarized statements from all the potential joint venture partners stating that they will enter into and abide by the provisions of the JVA in the instance that the bid is successful.

II. FINANCIAL COMPONENT ENVELOPE

- (j) Original of duly signed and accomplished Financial Bid Form; **and**

Other documentary requirements under RA No. 9184

- (k) Original of duly signed Bid Prices in the Bill of Quantities; **and**
- (l) Duly accomplished Detailed Estimates Form, including a summary sheet indicating the unit prices of construction materials, labor rates, and equipment rentals used in coming up with the Bid; **and**
- (m) Cash Flow by Quarter.

Section X. Forms

I. Bid form for the Procurement of Infrastructure Project

[Shall be submitted with the Bid]

Project Identification No. : _____

Date: _____

To: *[name and address of Procuring Entity]*

Having examined the Philippine Bidding Documents (PBDs) including the Supplemental or Bid Bulletin Numbers *[insert numbers]*, the receipt of which is hereby duly acknowledged, we, the undersigned, declare that:

- a. We have no reservation to the PBDs, including the Supplemental or Bid Bulletins, for the Procurement Project: *[insert name of contract]*;
- b. We offer to execute the Works for this Contract in accordance with the PBDs;
- c. The total price of our Bid in words and figures, excluding any discounts offered below is: *[insert information]*;
- d. The discounts offered and the methodology for their application are: *[insert information]*;
- e. The total bid price includes the cost of all taxes, such as, but not limited to: *[specify the applicable taxes, e.g. (i) value added tax (VAT), (ii) income tax, (iii) local taxes, and (iv) other fiscal levies and duties]*, which are itemized herein and reflected in the detailed estimates,
- f. Our Bid shall be valid within the a period stated in the PBDs, and it shall remain binding upon us at any time before the expiration of that period;
- g. If our Bid is accepted, we commit to obtain a Performance Security in the amount of *[insert percentage amount]* percent of the Contract Price for the due performance of the Contract, or a Performance Securing Declaration in lieu of the the allowable forms of Performance Security, subject to the terms and conditions of issued GPPB guidelines¹ for this purpose;
- h. We are not participating, as Bidders, in more than one Bid in this bidding process, other than alternative offers in accordance with the Bidding Documents;
- i. We understand that this Bid, together with your written acceptance thereof included in your notification of award, shall constitute a binding contract between us, until a formal Contract is prepared and executed; and
- j. We understand that you are not bound to accept the Lowest Calculated Bid or any other Bid that you may receive.
- k. We likewise certify/confirm that the undersigned, is the duly authorized representative of the bidder, and granted full power and authority to do, execute and perform any and all acts necessary to participate, submit the bid, and to sign and execute the ensuing contract for the *[Name of Project]* of the *[Name of the Procuring Entity]*.
- l. We acknowledge that failure to sign each and every page of this Bid Form, including the Bill of Quantities, shall be a ground for the rejection of our bid.

¹ currently based on GPPB Resolution No. 09-2020

Name: _____

Legal Capacity: _____

Signature: _____

Duly authorized to sign the Bid for and behalf of: _____

Date: _____

II. Omnibus Sworn Statement

[shall be submitted with the Bid]

REPUBLIC OF THE PHILIPPINES)

CITY/MUNICIPALITY OF _____) S.S.

AFFIDAVIT

I, [Name of Affiant], of legal age, [Civil Status], [Nationality], and residing at [Address of Affiant], after having been duly sworn in accordance with law, do hereby depose and state that:

1. *[Select one, delete the other:]*

[If a sole proprietorship:] I am the sole proprietor or authorized representative of [Name of Bidder] with office address at [address of Bidder];

[If a partnership, corporation, cooperative, or joint venture:] I am the duly authorized and designated representative of [Name of Bidder] with office address at [address of Bidder];

2. *[Select one, delete the other:]*

[If a sole proprietorship:] As the owner and sole proprietor, or authorized representative of [Name of Bidder], I have full power and authority to do, execute and perform any and all acts necessary to participate, submit the bid, and to sign and execute the ensuing contract for [Name of the Project] of the [Name of the Procuring Entity], as shown in the attached duly notarized Special Power of Attorney;

[If a partnership, corporation, cooperative, or joint venture:] I am granted full power and authority to do, execute and perform any and all acts necessary to participate, submit the bid, and to sign and execute the ensuing contract for [Name of the Project] of the [Name of the Procuring Entity], as shown in the attached [state title of attached document showing proof of authorization (e.g., duly notarized Secretary's Certificate, Board/Partnership Resolution, or Special Power of Attorney, whichever is applicable)];

3. [Name of Bidder] is not "blacklisted" or barred from bidding by the Government of the Philippines or any of its agencies, offices, corporations, or Local Government Units, foreign government/foreign or international financing institution whose blacklisting rules have been recognized by the Government Procurement Policy Board, **by itself or by relation, membership, association, affiliation, or controlling interest with another blacklisted person or entity as defined and provided for in the Uniform Guidelines on Blacklisting;**

4. Each of the documents submitted in satisfaction of the bidding requirements is an authentic copy of the original, complete, and all statements and information provided therein are true and correct;

5. [Name of Bidder] is authorizing the Head of the Procuring Entity or its duly authorized representative(s) to verify all the documents submitted;

6. *[Select one, delete the rest:]*

[If a sole proprietorship:] The owner or sole proprietor is not related to the Head of the Procuring Entity, members of the Bids and Awards Committee (BAC), the Technical Working Group, and the BAC Secretariat, the head of the Project Management Office or the end-user unit, and the project consultants by consanguinity or affinity up to the third civil degree;

[If a partnership or cooperative:] None of the officers and members of *[Name of Bidder]* is related to the Head of the Procuring Entity, members of the Bids and Awards Committee (BAC), the Technical Working Group, and the BAC Secretariat, the head of the Project Management Office or the end-user unit, and the project consultants by consanguinity or affinity up to the third civil degree;

[If a corporation or joint venture:] None of the officers, directors, and controlling stockholders of *[Name of Bidder]* is related to the Head of the Procuring Entity, members of the Bids and Awards Committee (BAC), the Technical Working Group, and the BAC Secretariat, the head of the Project Management Office or the end-user unit, and the project consultants by consanguinity or affinity up to the third civil degree;

7. *[Name of Bidder]* complies with existing labor laws and standards; and
8. *[Name of Bidder]* is aware of and has undertaken the responsibilities as a Bidder in compliance with the Philippine Bidding Documents, which includes:
 - a. Carefully examining all of the Bidding Documents;
 - b. Acknowledging all conditions, local or otherwise, affecting the implementation of the Contract;
 - c. Making an estimate of the facilities available and needed for the contract to be bid, if any; and
 - d. Inquiring or securing Supplemental/Bid Bulletin(s) issued for the *[Name of the Project]*.
9. *[Name of Bidder]* did not give or pay directly or indirectly, any commission, amount, fee, or any form of consideration, pecuniary or otherwise, to any person or official, personnel or representative of the government in relation to any procurement project or activity.
10. **In case advance payment was made or given, failure to perform or deliver any of the obligations and undertakings in the contract shall be sufficient grounds to constitute criminal liability for Swindling (Estafa) or the commission of fraud with unfaithfulness or abuse of confidence through misappropriating or converting any payment received by a person or entity under an obligation involving the duty to deliver certain goods or services, to the prejudice of the public and the government of the Philippines pursuant to Article 315 of Act No. 3815 s. 1930, as amended, or the Revised Penal Code.**

IN WITNESS WHEREOF, I have hereunto set my hand this ___ day of ___, 20__ at _____,
Philippines.

*[Insert NAME OF BIDDER OR ITS AUTHORIZED
REPRESENTATIVE]*

[Insert signatory's legal capacity]

Affiant

[Jurat]

[Format shall be based on the latest Rules on Notarial Practice]

III. Contract Agreement Form for the Procurement of Infrastructure Projects

[not required to be submitted with the Bid, but it shall be submitted within ten (10) days after receiving the Notice of Award]

CONTRACT AGREEMENT

THIS AGREEMENT, made this *[insert date]* day of *[insert month]*, *[insert year]* between *[name and address of PROCURING ENTITY]* (hereinafter called the “Entity”) and *[name and address of Contractor]* (hereinafter called the “Contractor”).

WHEREAS, the Entity is desirous that the Contractor execute *[name and identification number of contract]* (hereinafter called “the Works”) and the Entity has accepted the Bid for *[contract price in words and figures in specified currency]* by the Contractor for the execution and completion of such Works and the remedying of any defects therein.

NOW THIS AGREEMENT WITNESSETH AS FOLLOWS:

1. In this Agreement, words and expressions shall have the same meanings as are respectively assigned to them in the Conditions of Contract hereinafter referred to.
2. The following documents as required by the 2016 revised Implementing Rules and Regulations of Republic Act No. 9184 shall be deemed to form and be read and construed as part of this Agreement, *viz.*:
 - a. Philippine Bidding Documents (PBDs);
 - i. Drawings/Plans;
 - ii. Specifications;
 - iii. Bill of Quantities;
 - iv. General and Special Conditions of Contract;
 - v. Supplemental or Bid Bulletins, if any;
 - b. Winning bidder’s bid, including the Eligibility requirements, Technical and Financial Proposals, and all other documents or statements submitted;
Bid form, including all the documents/statements contained in the Bidder’s bidding envelopes, as annexes, and all other documents submitted (*e.g.*, Bidder’s response to request for clarifications on the bid), including corrections to the bid, if any, resulting from the Procuring Entity’s bid evaluation;
 - c. Performance Security;
 - d. Notice of Award of Contract and the Bidder’s conforme thereto; and
 - e. Other contract documents that may be required by existing laws and/or the Procuring Entity concerned in the PBDs.

Winning bidder agrees that additional contract documents or information prescribed by the GPPB that are subsequently required for submission after the contract execution, such as the Notice to Proceed, Variation Orders, and Warranty Security, shall likewise form part of the Contract.

3. In consideration for the sum of *[total contract price in words and figures]* or such other sums as may be ascertained, *[Named of the bidder]* agrees to *[state the object of the contract]* in accordance with his/her/its Bid.
4. The *[Name of the procuring entity]* agrees to pay the above-mentioned sum in accordance with the terms of the Bidding.

IN WITNESS whereof the parties thereto have caused this Agreement to be executed the day and year first before written.

[Insert Name and Signature]

[Insert Name and Signature]

[Insert Signatory's Legal Capacity]

[Insert Signatory's Legal Capacity]

for:

for:

[Insert Procuring Entity]

[Insert Name of Supplier]

Acknowledgment

[Format shall be based on the latest Rules on Notarial Practice]

IV. Bid Security Declaration Form

[Shall be submitted with the Bid if bidder opts to provide this form of bid security]

REPUBLIC OF THE PHILIPPINES)

CITY OF _____) S.S.

BID SECURING DECLARATION

Project Identification No.: *[Insert number]*

To: *[Insert name and address of the Procuring Entity]*

I/We, the undersigned, declare that:

1. I/We understand that, according to your conditions, bids must be supported by a Bid Security, which may be in the form of a Bid Securing Declaration.
2. I/We accept that: (a) I/we will be automatically disqualified from bidding for any procurement contract with any procuring entity for a period of two (2) years upon receipt of your Blacklisting Order; and, (b) I/we will pay the applicable fine provided under Section 6 of the Guidelines on the Use of Bid Securing Declaration, within fifteen (15) days from receipt of the written demand by the procuring entity for the commission of acts resulting to the enforcement of the bid securing declaration under Sections 23.1(b), 34.2, 40.1 and 69.1, except 69.1(f), of the IRR of RA No. 9184; without prejudice to other legal action the government may undertake.
3. I/We understand that this Bid Securing Declaration shall cease to be valid on the following circumstances:
 - a. Upon expiration of the bid validity period, or any extension thereof pursuant to your request;
 - b. I am/we are declared ineligible or post-disqualified upon receipt of your notice to such effect, and (i) I/we failed to timely file a request for reconsideration or (ii) I/we filed a waiver to avail of said right; and
 - c. I am/we are declared the bidder with the Lowest Calculated Responsive Bid, and I/we have furnished the performance security and signed the Contract.

IN WITNESS WHEREOF, I/We have hereunto set my/our hand/s this ____ day of [month] [year] at [place of execution].

[Insert NAME OF BIDDER OR ITS AUTHORIZED REPRESENTATIVE]

[Insert signatory's legal capacity]

Affiant

[Jurat]

[Format shall be based on the latest Rules on Notarial Practice]

V. Statement of Single Largest Completed Contract (SLCC) Similar to the Contract to be Bid

Business Name: _____
 Business Address: _____

Name of Contract	A. Owner Name B. Address C. Telephone Nos.	Nature of Work	Contractor's Role		A. Amount at Award	A. Date Awarded
			Description	%	B. Amount at Completion	B. Date Completed
<i>Government</i>						
<i>Private</i>						

Note: This statement shall be supported by:

1. Notice of Awards and/or Notice to Proceed
2. Certificate of Completion, Project Owner's Certificate of Final Acceptance issued by the Owner other than the Contractor or the Constructors Performance Evaluation system (CPES) Final Rating, which must be at least satisfactory. In case of contracts with the private sector, an equivalent document shall be submitted.

Submitted by: _____
(Printed Name & Signature of Authorized Representative)

Designation: _____

Date: _____